

 **DEĞİŞİM** furniture accessories



**product collection catalog**  
***we start the change***  
degisimkulp.com



**we start the change**



**DEĞİŞİM**  
**furniture accessories**

[degisimkulp.com](http://degisimkulp.com)

## HAKKIMIZDA / ABOUT

2013 yılında Alüminyum Kulp sektörüne giren firmamız, yıllar geçtikçe ürün gamı ve satış gücünü arttırarak Mobilya aksesuarları kulp üretimi ve endüstriyel üretim yapmaktadır. Kurumsal vizyonumuz açısından, yenilik ve değişim en mühim hedeflerimiz arasındadır. Bu sebeple her yıl büyüyen üretim kapasitemiz ve çalışan sayımızla bölgesel kalkınmanın birer aracı olma yolunda hızla ilerlemekteyiz.

İç mekan, dış mekan, hareketli, sabit, ahşap, metal, plastik, cam ve kompozit mobilya sektörleri gibi sayısız mobilya endüstrisine hitap eden Değişim Kulp ürün gamını arttırdıkça her geçen gün tasarımlarıyla alt sektörler doğuran mobilya endüstrisine hizmet edecektir.

İmalat sektörüne getirdiğimiz yenilikçi bakış açısı, teknolojik ve modern yatırımlarımıza doğrudan etki etmiş, bu sayede üretim bandımızdan en yeni ürünlerimizi elde etmekte ve mobilya sektörüne kesintisiz hizmetler sunmaktayız. Ayrıca ürünlerimizi müşterilerimize özel şekilde Tasarlayarak bu sayede ihtiyaçları tam anlamı ile karşılayabilmekteyiz. Sektörde marka değeri hızla artan firmamızın yakın zamanda yurtdışı satışları ile güvenilirliğini ve istikrarını tescil ettirecektir.

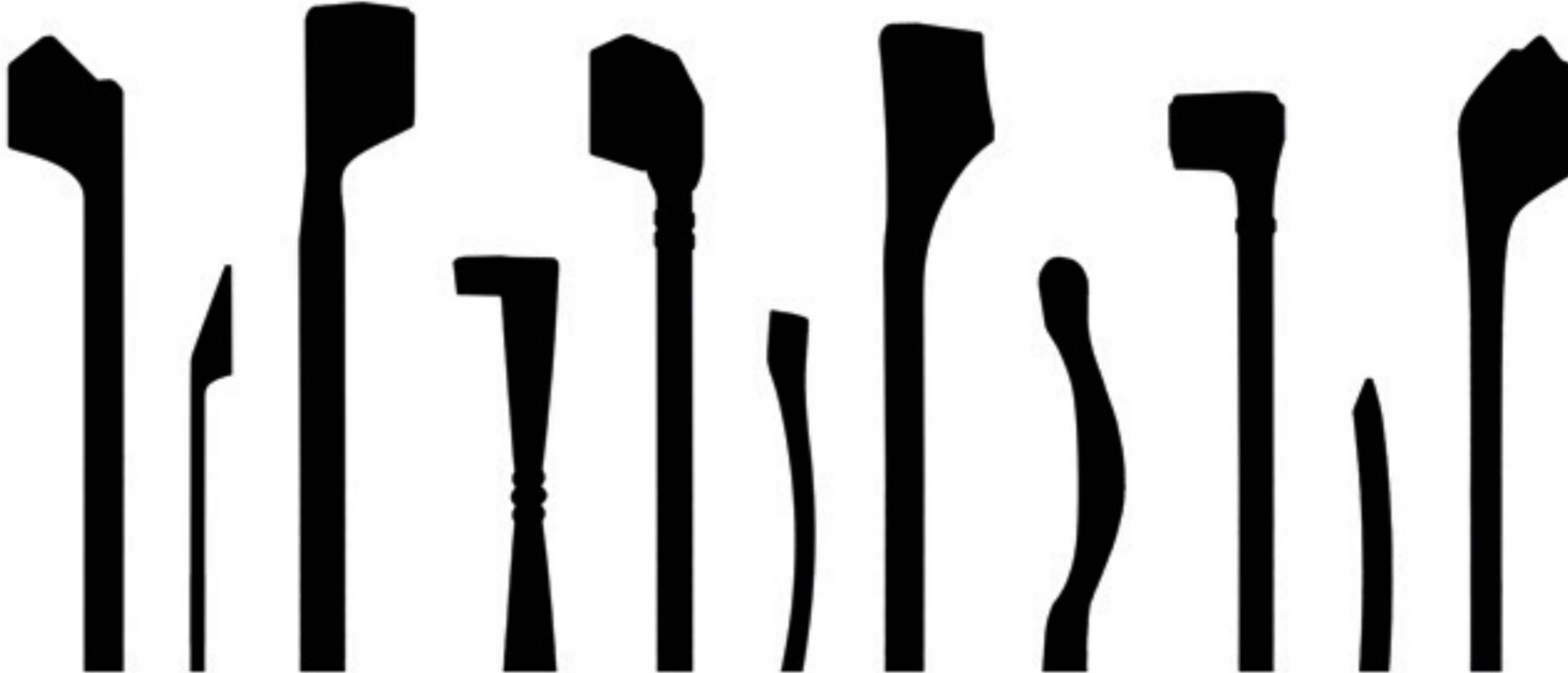



we start the change

# DEĞİŞİM



[degisimkulp.com](http://degisimkulp.com)





# furniture accessories



**New Model**  
Yeni Ürün  
Page / 17 - 30





# İndeks / Contents

17

**Lux Zamak Kulplar** / Luxury Zinc Alloy ( Zamac ) Handles

47

**Eko Zamak Kulplar** / Eco Zinc Alloy ( Zamac ) Handles

55

**Aluminyum Kulplar** / Aluminum Handles

91

**Aluminyum CNC Kulplar** / Aluminum CNC Handles

137

**Porselen Kulplar** / Porcelain Handles

141



**Askı & Portmanto** / Hook & Coat Rack

155



**Düğmeler** / Knob & Buttons



## Kulp Renkleri / Handle Colors



**KROM / Chrome**



**ALTIN / Gold**



**FÜME / Smoke**



**BRONZ / Bronze**



**MAT KROM / Mat Chrome**



**SİYAH / Black**



**BEYAZ / White**



**MAT ALTIN / Mat Gold**



**ROSE / Rose**



**ANTİK BAKIR**  
Antique Copper



**ANTİK SARI**  
Antique Yellow



**ANTİK GÜMÜŞ**  
Antique Silver

## Porselen Desenleri / Porcelain Pattern



07



08



09



10



11



12A



15



BEYAZ



01



02



03



04



05



06

Porselen Siparişlerinizi Kod ve Renk Kartela Kodları İle Birlikte Veriniz...





## OUR PRODUCT RANGE

Handle / Knobs



# SPECIALLY PRODUCED

for you to feel the change

[degisimkulp.com](http://degisimkulp.com)





The quality of our **handle** and knob products stands out for many reasons. we are working We highlight our quality.





# **Export / İhracat**

---

Değişim Kulp, başta Ortadoğu ülkeleri olmak üzere Avrupa pazarlarına da ihracat yapmaktadır. Ürünlerimiz, kalite ve estetik anlayışımızla Ortadoğu'da geniş bir müşteri kitlesi tarafından tercih edilmektedir. Modern üretim tesislerimizden çıkan her bir kulp, titiz kalite kontrollerinden geçerek uluslararası standartlarda müşterilerimize sunulmaktadır.

Değişim Kulp olarak, güçlü ihracat ağımla sınırları aşıyor ve ürünlerimizi dünyaya ulaştırıyoruz. İhracat Yaptığımız Ülkeler ; Tunus Cezayir - Libya - Fas - Ürdün - Suriye - Irak - Azerbaycan - Mısır ve Balkan Ülkeleri Oluşmaktadır.

Değişim Kulp primarily exports to Middle Eastern countries and also to European markets. Our products are highly preferred in the Middle East for their quality and aesthetic appeal. Each handle produced in our modern facilities undergoes rigorous quality checks to meet international standards.

With a strong export network, Değişim Kulp delivers its high-quality products worldwide, connecting our craftsmanship with global markets. Countries we export to ; Jordan - Morocco - Syria - Irak - Azerbaycan - Egypt - Tunisian Algeria and balkan countries.

# **R&D / Arge**

---

Değişim Kulp Olarak Ar-Ge Çalışmalarımızda Yenilikçi Çözümler ve Müşteri Odaklı Tasarımlar Geliştirmek İçin Çalışıyoruz.Modern Üretim Süreçlerimize Entegre Ettiğimiz Ar-Ge Faaliyetlerimiz, Ürünlerimizin Fonksiyonelliğini ve Estetiğini Sürekli Olarak İyileştirmemizi Sağlıyor. Malzeme Seçimi, Üretim Teknikleri ve Ergonomik Tasarımlar Üzerinde Yaptığımız Çalışmalarla Sektörde Sektörde Fark Yaratıyoruz.

Ar-Ge Ekibimiz, Yenilikçi Düşüncelerimiz İle Markamızı Geleceğe Taşıyoruz...



# Export / Ar-Ge

Enjeksiyon - Paketleme - Kaplama

Injection - packaging - polishing - plating





## ***Kapasite / Capacity***

---

Değişim Kulp, Modern Üretim Tesisleri ve İleri Teknoloji Makineleriyle Yüksek Üretim Kapasitesine Sahiptir. Günlük Üretim Hacmimiz, Geniş Ürün Yelpazemizle Birlikte Müşteri Taleplerini Hızlı ve Verimli Bir Şekilde Karşılacak Düzeydedir. CNC İşleme, Zamak Döküm ve ALüminyum İşleme Gibi Farklı Üretim Tekniklerini Aynı Çatı Altında Buluşturarak, Her Ay Binlerce Kaliteli Mobilya Kulp ve Aksesuarları Üretiyoruz.

Bu Kapasite Hem Yurtiçi Hemde Yurtdışı Pazarlarındaki Müşterilerimize Kesintisiz Hizmet Sunmamızı Sağlar. Üretim Gücümüz, Esnekliğimiz ve Hızlı Teslimat Süremizle Rekabetçi Bir Avantaj Sunuyoruz.

## ***Manufacturing / Üretim***

---

Değişim Kulp olarak, üretim süreçlerimizde modern ve yenilikçi teknikler kullanıyoruz. Üretim tesislerimizde CNC işleme, zamak döküm, alüminyum işleme gibi teknolojilerden faydalanıyoruz. CNC işleme, yüksek hassasiyetle kompleks şekillerin işlenmesini sağlarken, zamak döküm dayanıklı ve detaylı tasarımlar üretmek için kullanılıyor. Alüminyum işleme ise hafif ve korozyona dayanıklı ürünler üretmemize olanak tanıyor. Üretim hattımızda tam otomasyon sağlanarak iş süreçleri hızlandırılırken, kalite kontrol aşamalarıyla her ürünün standarda uygunluğu titizlikle denetlenir. Böylece estetik, dayanıklılık ve işlevselliği bir arada sunan yüksek kaliteli kulplar üretiyoruz.

Değişim Kulp boasts a high production capacity with modern facilities and advanced machinery. Our daily production volume is designed to meet customer demands efficiently and quickly, thanks to our wide range of products. By combining various manufacturing techniques such as CNC machining, zamak casting, and aluminum processing under one roof, we produce thousands of high-quality handles and accessories each month. This capacity allows us to serve both domestic and international markets without interruption. Our production strength, flexibility, and fast delivery processes provide a competitive advantage that sets us apart.

تتميز شركة Değişim بمرافق إنتاج حديثة وآلات تكنولوجيا متقدمة، مما يمنحها سعة إنتاجية عالية. إن حجم الإنتاج اليومي لدينا، مع تنوع منتجاتنا الواسع، يتيح لنا تلبية احتياجات العملاء بسرعة وكفاءة. نقوم بتجميع تقنيات إنتاج مختلفة مثل التصنيع باستخدام الحاسب الآلي، وصب الزاماك، ومعالجة الألمنيوم تحت سقف واحد، مما يمكننا من إنتاج آلاف المقابض والإكسسوارات عالية الجودة شهرياً. هذه السعة تتيح لنا تقديم خدمات مستمرة لعملائنا في الأسواق المحلية والدولية. تميزنا يكمن في قوتنا الإنتاجية، ومرونتنا، وسرعة عمليات التسليم التي تمنحنا ميزة تنافسية كبيرة.



# Kapasite / Üretim

500.000 Adet ve Üzeri Aylık Kapasite

Monthly Capacity of 500,000 Pieces and Above

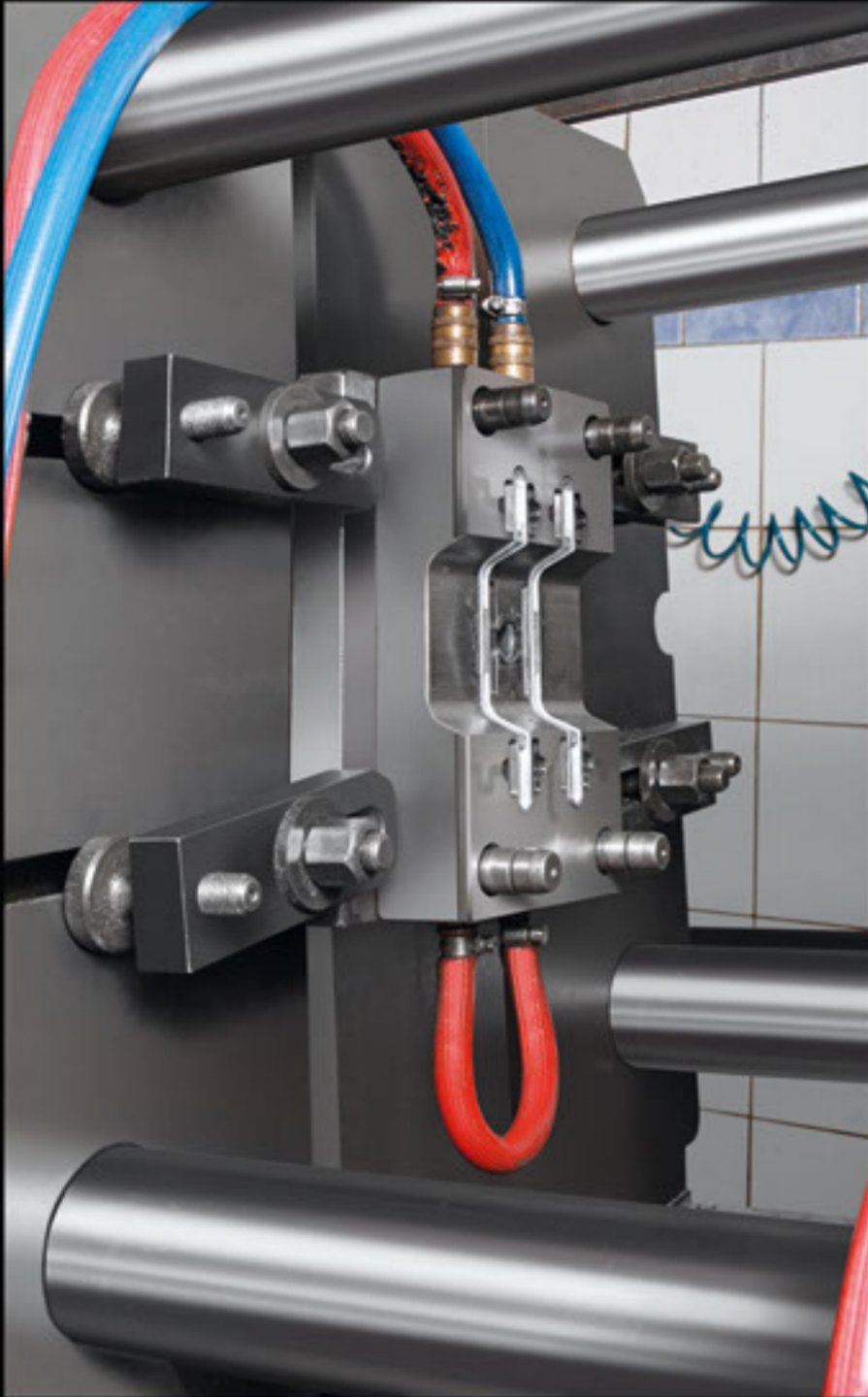



---

***The duty of humanity should be to***



**PROTECT  
NATURE**

**The world is our home !**





## The duty of humanity

Learn about the environment. Prevent pollution. Separate your waste and contribute to recycling. Reduce use of plastic bags.

Thanks to the environment protection awareness, water, air and soil pollution is prevented, natural life protected, carbon footprint decreases, global warming and greenhouse gas effects is protected and a beautiful world is left to future generations.







# *Lux Seri / Zamak*

Lux Zamak Kulpların Gücü ve Zarafeti  
Mobilyalarınıza Ayrıcalık Katacak.



128mm / 160 mm / 224 mm. Karizma LUX Serisi Zamak Kulp  
Siyah - Krom - İnox - Altın ve Daha Birçok Renk Seçenekleri  
ile Sizlerin Beğenisine Sunulmaktadır.





**New Model**  
Karizma







T.T.No: 2024 / 007188

50

**Zion**

2021

Siyah ●

Krom ●

İnox ●

Altın ●

Rose ●

Füme ●



Zion	ÖLÇÜ	📦	Siyah	Krom	İnox	Altın
Code : 2021	128 mm	50	50,33	57,60	63,36	69,70
	160 mm	50	57,26	64,98	71,48	78,63
	224 mm	50	70,69	79,45	87,39	96,13



T.T.No: 2024 / 007188

50

**Neon**

2022

Siyah ●

Krom ●

İnox ●

Altın ●

Rose ●

Füme ●



Neon	ÖLÇÜ	📦	Siyah	Krom	İnox	Altın
Code : 2022	128 mm	50	50,33	57,60	63,36	69,70
	160 mm	50	57,26	64,98	71,48	78,63
	224 mm	50	70,69	79,45	87,39	96,13

ZINC  
ALLOY

17



# LUX ZAMAK

Luxury Zinc Alloy



T.T.No: 2024 / 007188



**Titan** 50

2023

- Siyah
- Krom
- İnox
- Altın
- Rose
- Füme

Titan	ÖLÇÜ	Box	Siyah	Krom	İnox	Altın
Code : 2023	128 mm	50	50,33	57,60	63,36	69,70
	160 mm	50	57,26	64,98	71,48	78,63
	224 mm	50	70,69	79,45	87,39	96,13

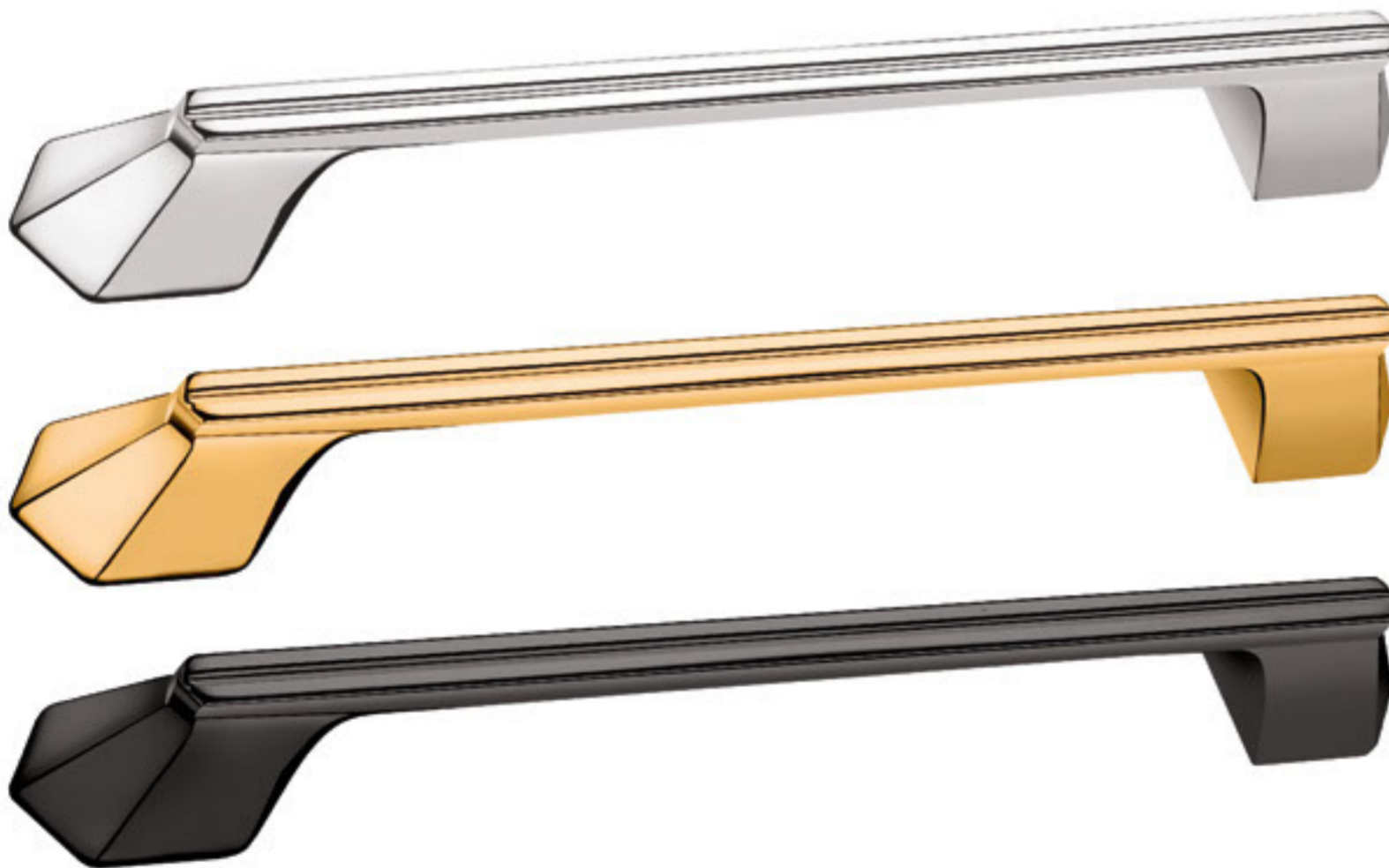

T.T.No: 2024 / 007188



**Nova** 50

2024

- Siyah
- Krom
- İnox
- Altın
- Rose
- Füme

Nova	ÖLÇÜ	Box	Siyah	Krom	İnox	Altın
Code : 2024	128 mm	50	50,33	57,60	63,36	69,70
	160 mm	50	57,26	64,98	71,48	78,63
	224 mm	50	70,69	79,45	87,39	96,13

ZINC  
ALLOY

18





T.T.No: 2024 / 007188

50

## Zenit

2025

Siyah ●

Krom ●

İnox ●

Altın ●

Rose ●

Füme ●



### Zenit

Code : 2025

ÖLÇÜ	Box	Siyah	Krom	İnox	Altın
128 mm	50	50,33	57,60	63,36	69,70
160 mm	50	57,26	64,98	71,48	78,63
224 mm	50	70,69	79,45	87,39	96,13



T.T.No: 2024 / 001237

50

## Peru

2026

Siyah ●

Krom ●

İnox ●

Altın ●

Rose ●

Füme ●



### Peru

Code : 2026

ÖLÇÜ	Box	Siyah	Krom	İnox	Altın
128 mm	50	49,27	56,54	62,20	68,42
160 mm	50	54,61	62,33	68,57	75,42
224 mm	50	65,38	74,15	81,56	89,72

ZINC  
ALLOY

19



# LUX ZAMAK

Luxury Zinc Alloy



T.T.No: 2024 / 001237



**Pelin**

50

2027

- Siyah
- Krom
- İnox
- Altın
- Rose
- Füme

Pelin	ÖLÇÜ		Siyah	Krom	İnox	Altın
Code : 2027	128 mm	50	49,27	56,54	62,20	68,42
	160 mm	50	54,61	62,33	68,57	75,42
	224 mm	50	65,38	74,15	81,56	89,72



T.T.No: 2024 / 001237



**Lotus**

50

2028

- Siyah
- Krom
- İnox
- Altın
- Rose
- Füme

Lotus	ÖLÇÜ		Siyah	Krom	İnox	Altın
Code : 2028	128 mm	50	49,27	56,54	62,20	68,42
	160 mm	50	54,61	62,33	68,57	75,42
	224 mm	50	65,38	74,15	81,56	89,72

ZINC  
ALLOY

20





T.T.No: 2024 / 001237

50

Karizma

2029

Siyah

Krom

İnox

Altın

Rose

Füme



Karizma

Code :2029

ÖLÇÜ



Siyah

Krom

İnox

Altın

128 mm

50

49,27

56,54

62,20

68,42

160 mm

50

54,61

62,33

68,57

75,42

224 mm

50

65,38

74,15

81,56

89,72



T.T.No: 2024 / 001237

50

Kobra

2030

Siyah

Krom

İnox

Altın

Rose

Füme



Kobra

Code : 2030

ÖLÇÜ



Siyah

Krom

İnox

Altın

128 mm

50

49,27

56,54

62,20

68,42

160 mm

50

54,61

62,33

68,57

75,42

224 mm

50

65,38

74,15

81,56

89,72

ZINC  
ALLOY

21



# LUX ZAMAK

Luxury Zinc Alloy



T.T.No: 2024 / 007188



**Argon** 50

2031



- Siyah
- Krom
- İnox
- Altın
- Rose
- FÜME

Argon	ÖLÇÜ		Siyah	Krom	İnox	Altın
Code : 2031	128 mm	50	50,33	57,60	63,36	69,70
	160 mm	50	57,26	64,98	71,48	78,63
	224 mm	50	70,69	79,45	87,39	96,13

T.T.No: 2024 / 007188



**Hammer** 50

2032



- Siyah
- Krom
- İnox
- Altın
- Rose
- FÜME

Hammer	ÖLÇÜ		Siyah	Krom	İnox	Altın
Code : 2032	128 mm	50	50,33	57,60	63,36	69,70
	160 mm	50	57,26	64,98	71,48	78,63
	224 mm	50	70,69	79,45	87,39	96,13

ZINC  
ALLOY

22





T.T.No: 2024 / 007188

50

**Kripton**

2033

Siyah ●

Krom ●

İnox ●

Altın ●

Rose ●

Füme ●

**Kripton**

Code : 2033

**ÖLÇÜ**

Siyah

Krom

İnox

Altın

128 mm

50

50,33

57,60

63,36

69,70

160 mm

50

57,26

64,98

71,48

78,63

224 mm

50

70,69

79,45

87,39

96,13



T.T.No: 2024 / 007188

50

**Mirage**

2034

Siyah ●

Krom ●

İnox ●

Altın ●

Rose ●

Füme ●

**Mirage**

Code : 2034

**ÖLÇÜ**

Siyah

Krom

İnox

Altın

128 mm

50

50,33

57,60

63,36

69,70

160 mm

50

57,26

64,98

71,48

78,63

224 mm

50

70,69

79,45

87,39

96,13

 ZINC  
ALLOY

23



# LUX ZAMAK

Luxury Zinc Alloy



T.T.No: 2024 / 007188



**Solaris** 50

2035



- Siyah
- Krom
- İnox
- Altın
- Rose
- FÜME

Solaris	ÖLÇÜ	Box	Siyah	Krom	İnox	Altın
Code : 2035	128 mm	50	50,33	57,60	63,36	69,70
	160 mm	50	57,26	64,98	71,48	78,63
	224 mm	50	70,69	79,45	87,39	96,13

T.T.No: 2024 / 007188



**Lunar** 50

2036



- Siyah
- Krom
- İnox
- Altın
- Rose
- FÜME

Lunar	ÖLÇÜ	Box	Siyah	Krom	İnox	Altın
Code : 2036	128 mm	50	50,33	57,60	63,36	69,70
	160 mm	50	57,26	64,98	71,48	78,63
	224 mm	50	70,69	79,45	87,39	96,13

ZINC  
ALLOY

24





T.T.No: 2024 / 007188

50

**Astro**

2037

- Siyah ●
- Krom ●
- İnox ●
- Altın ●
- Rose ●
- Füme ●



Astro	ÖLÇÜ	İkon	Siyah	Krom	İnox	Altın
Code : 2037	128 mm	50	50,33	57,60	63,36	69,70
	160 mm	50	57,26	64,98	71,48	78,63
	224 mm	50	70,69	79,45	87,39	96,13



T.T.No: 2024 / 007188

50

**Helix**

2038

- Siyah ●
- Krom ●
- İnox ●
- Altın ●
- Rose ●
- Füme ●



Helix	ÖLÇÜ	İkon	Siyah	Krom	İnox	Altın
Code : 2038	128 mm	50	50,33	57,60	63,36	69,70
	160 mm	50	57,26	64,98	71,48	78,63
	224 mm	50	70,69	79,45	87,39	96,13

ZINC  
ALLOY

25



# LUX ZAMAK

Luxury Zinc Alloy



**Derya** 50

2039



- Siyah
- Krom
- İnox
- Altın
- Rose
- Füme

Derya	ÖLÇÜ		Siyah	Krom	İnox	Altın
Code : 2039	160 mm	50	54,00	54,00	64,00	66,00
	192 mm	50	67,50	67,50	74,00	80,00
	224 mm	50	81,00	81,00	88,00	96,00



**Lodos** 50

2040



- Siyah
- Krom
- İnox
- Altın
- Rose
- Füme

Lodos	ÖLÇÜ		Siyah	Krom	İnox	Altın
Code : 2040	160 mm	50	56,20	63,92	70,32	77,35
	224 mm	50	72,28	81,04	89,14	98,06

ZINC  
ALLOY

26





**50 İvana**

2041

- Siyah ●
- Krom ●
- İnox ●
- Altın ●
- Rose ●
- Füme ●



İvana	ÖLÇÜ	İkon	Siyah	Krom	İnox	Altın
Code : 2041	128 mm	50	72,50	72,50	78,50	83,00
	160 mm	50	84,50	84,50	91,00	98,00



**50 Eos**

2042

- Siyah ●
- Krom ●
- İnox ●
- Altın ●
- Rose ●
- Füme ●



Eos	ÖLÇÜ	İkon	Siyah	Krom	İnox	Altın
Code : 2042	128 mm	50	50,50	50,50	55,00	60,50
	160 mm	50	57,00	57,00	63,00	70,00
	192 mm	50	64,50	64,50	71,00	77,00
	224 mm	50	74,00	74,00	82,00	89,00



# LUX ZAMAK

Luxury Zinc Alloy



**Hayat** 50

2043



- Siyah
- Krom
- İnox
- Altın
- Rose
- FÜME

Hayat	ÖLÇÜ		Siyah	Krom	İnox	Altın
Code : 2043	160 mm	50	58,50	58,50	65,50	71,50
	224 mm	50	71,00	71,00	78,50	87,00



**Kaçkar** 50

2044

T.T.No: 2017 / 00430



- Siyah
- Krom
- İnox
- Altın
- Rose
- FÜME

Kaçkar	ÖLÇÜ		Siyah	Krom	Altın
Code : 2044	160 mm	50	72,00	72,00	78,00

ZINC  
ALLOY

28





#### 50 Halis

- Siyah ●
- Krom ●
- Inox ●
- Altın ●
- Rose ●
- Füme ●

2045

T.T.No: 2017 / 00430



Halis	ÖLÇÜ		Siyah	Krom	Altın
Code : 2045	160 mm	50	72,00	72,00	78,00



#### 50 Elmas

- Siyah ●
- Krom ●
- Inox ●
- Altın ●
- Rose ●
- Füme ●

2046

T.T.No: 2017 / 00430



Elmas	ÖLÇÜ		Siyah	Krom	Inox	Altın
Code : 2046	160 mm	50	65,00	65,00	70,20	71,00



# LUX ZAMAK

Luxury Zinc Alloy



**Linda** 50

2047



- Siyah
- Krom
- İnox
- Altın
- Rose
- Füme

Linda	ÖLÇÜ	Box	Siyah	Krom	İnox	Altın
Code : 2047	128 mm	50	58,50	58,50	62,50	68,50
	160 mm	50	63,50	63,50	68,50	76,00
	192 mm	50	70,50	70,50	75,50	83,00
	224 mm	50	76,00	76,00	81,50	90,50



**Perla** 50

2048



- Siyah
- Krom
- İnox
- Altın
- Rose
- Füme

Perla	ÖLÇÜ	Box	Siyah	Krom	İnox	Altın
Code : 2047	128 mm	50	51,50	51,50	55,50	61,00
	160 mm	50	59,00	59,00	64,00	71,00
	192 mm	50	66,00	66,00	71,50	78,00
	224 mm	50	74,50	74,50	81,00	89,50

ZINC  
ALLOY

30





DEĞİŞİM furniture accesories

# *Zamak Kulplar*



Zamak Kulpların Gücü ve Dayanıklılığı  
Mobilyalarınıza Sağlamlık Katar...





DEĞİŞİM furniture accesories



[degisimkulp.com](http://degisimkulp.com)





**50 Anamur**

574

- Siyah ●
- Krom ●
- İnox ●
- Altın ●
- Rose ●
- Füme ●



Anamur	ÖLÇÜ	İkon	Siyah	Krom	İnox	Altın
574	128 - 160 mm	50	36,47	43,57	47,93	52,72
	192 - 224 mm	50	41,31	49,77	54,75	60,22



**50 Amasra**

575

- Siyah ●
- Krom ●
- İnox ●
- Altın ●
- Rose ●
- Füme ●



Amasra	ÖLÇÜ	İkon	Siyah	Krom	İnox	Altın
575	128 - 160 mm	50	37,45	44,55	49,00	53,90
	192 - 224 mm	50	44,23	52,70	57,97	63,76

ZINC  
ALLOY

31



# LUX ZAMAK

Luxury Zinc Alloy

DEĞİŞİM



Mercan 50

571



- Siyah
- Krom
- İnox
- Altın
- Rose
- Füme

Mercan	ÖLÇÜ	Box	Siyah	Krom	İnox	Altın
571	96 - 128 mm	50	34,74	40,20	44,22	48,64
	160 - 192 mm	50	43,00	50,78	55,86	61,45
	224 - 256 mm	50	53,18	61,92	68,11	74,92



Aysima 50

573



- Siyah
- Krom
- İnox
- Altın
- Rose
- Füme

Aysima	ÖLÇÜ	Box	Siyah	Krom	İnox	Altın
573	128 - 160 mm	50	34,52	41,62	45,79	50,36
	192 - 224 mm	50	40,33	48,80	53,68	59,04

ZINC  
ALLOY

32





#### 50 Favori

572

- Siyah ●
- Krom ●
- İnox ●
- Altın ●
- Rose ●
- Füme ●



Favori	ÖLÇÜ	Box	Siyah	Krom	İnox	Altın
572	128 - 160 mm	50	51,21	59,95	65,94	72,54
	192 - 224 mm	50	61,52	71,76	78,94	86,83



#### 50 Tuna

576

- Siyah ●
- Krom ●
- İnox ●
- Altın ●
- Rose ●
- Füme ●



Tuna	ÖLÇÜ	Box	Siyah	Krom	İnox	Altın
576	128 mm	50	33,49	38,95	42,85	47,13
	160 mm	50	36,88	44,66	49,13	54,04
	192 mm	50	42,19	50,92	56,01	61,62
	224 mm	50	45,60	54,33	59,77	65,74



#### 50 Mervan

2049

- Siyah ●
- Krom ●
- İnox ●
- Altın ●
- Rose ●
- Füme ●



Mervan	ÖLÇÜ	Box	Siyah	Krom	İnox	Altın
Code : 2049	128 mm	50	39,23	45,24	49,76	54,74
	160 mm	50	43,66	50,81	55,89	61,48
	192 mm	50	48,38	55,82	61,40	67,54

ZINC  
ALLOY

33



# LUX ZAMAK

Luxury Zinc Alloy



**Karden 50**

2050



- Siyah
- Krom
- İnox
- Altın
- Rose
- Füme

Karden	ÖLÇÜ	Box	Siyah	Krom	İnox	Altın
Code : 2050	96 mm	50	38,75	43,50	47,85	52,64
	128 mm	50	44,18	49,52	54,48	59,92
	160 mm	50	49,08	55,61	61,17	67,29



**Asus Damla 50**

2051



- Siyah
- Krom
- İnox
- Altın
- Rose
- Füme

Asus Damla	ÖLÇÜ	Box	Siyah	Krom	Altın
Code : 2051	96 mm	50	31,50	44,00	45,00
	128 mm	50	42,00	50,50	58,00



**Kare 50**

2052



- Siyah
- Krom
- İnox
- Altın
- Rose
- Füme

Kare	ÖLÇÜ	Box	Siyah	Krom	Altın
Code : 2052	96 mm	50	40,00	48,00	53,00
	128 mm	50	49,00	57,50	64,50

ZINC  
ALLOY

34



**50 Tombik**

2053

- Siyah ●
- Krom ●
- İnox ●
- Altın ●
- Rose ●
- Füme ●

**Tombik**

Code : 2053

ÖLÇÜ	Box	Siyah	Krom	İnox	Altın
96 mm	50	63,09	65,26	62,84	67,06
128 mm	50	65,26	67,94	65,43	69,84
160 mm	50	67,72	70,92	68,30	72,93
192 mm	50	69,88	73,61	70,88	75,72
224 mm	50	72,34	76,59	73,75	78,81
256 mm	50	74,80	79,57	76,63	81,89
288 mm	50	76,96	82,26	79,21	84,68
320 mm	50	80,01	85,83	82,65	88,36

**50 Yaren**

2054

- Siyah ●
- Krom ●
- İnox ●
- Altın ●
- Rose ●
- Füme ●

**Yaren**

Code : 2054

ÖLÇÜ	Box	Siyah	Krom	İnox	Altın
96 mm	50	31,05	33,04	33,04	34,69
128 mm	50	32,49	34,96	34,96	36,71
160 mm	50	33,93	36,88	36,88	38,73
192 mm	50	35,38	38,80	38,80	40,75
224 mm	50	36,82	40,73	40,73	42,76
256 mm	50	38,26	42,65	42,65	44,78
288 mm	50	39,70	44,57	44,57	46,80
320 mm	50	41,14	46,49	46,49	48,82



# LUX ZAMAK

Luxury Zinc Alloy

DEĞİŞİM



Yüzük



50

2055

- Siyah
- Krom
- İnox
- Altın
- Rose
- Füme

Yüzük	ÖLÇÜ	Box	Siyah	Krom	Çift Renk	Altın
Code : 2055	96 mm	50	25,48	27,47	25,37	29,12
	128 mm	50	26,92	29,39	26,60	31,14
	160 mm	50	28,36	31,31	27,82	33,16
	192 mm	50	29,81	33,24	29,04	35,18
	224 mm	50	31,25	35,16	30,26	37,19
	256 mm	50	32,69	37,08	31,49	39,21
	288 mm	50	34,13	39,00	32,71	41,23
	320 mm	50	35,57	40,92	33,93	43,25



Ovacık



50

2056

- Siyah
- Krom
- İnox
- Altın
- Rose
- Füme

Ovacık	ÖLÇÜ	Box	Siyah	Krom	Çift Renk	Altın
Code : 2056	96 mm	50	25,48	27,47	25,37	29,12
	128 mm	50	26,92	29,39	26,60	31,14
	160 mm	50	28,36	31,31	27,82	33,16
	192 mm	50	29,81	33,24	29,04	35,18
	224 mm	50	31,25	35,16	30,26	37,19
	256 mm	50	32,69	37,08	31,49	39,21
	288 mm	50	34,13	39,00	32,71	41,23
	320 mm	50	35,57	40,92	33,93	43,25

ZINC  
ALLOY

36





## 50 Tas Kulp

2057

- Siyah ●
- Krom ●
- İnox ●
- Altın ●
- Rose ●
- Füme ●



Tas Kulp	ÖLÇÜ	İkon	Siyah	Krom	İnox	Altın
Code : 2057	64 mm	50	30,56	39,47	43,42	47,76
	96 mm	50	38,35	49,04	53,94	59,34
	128 mm	50	42,63	53,77	59,15	65,06



## 50 Nora

2058

- Siyah ●
- Krom ●
- İnox ●
- Altın ●
- Rose ●
- Füme ●



Nora	ÖLÇÜ	İkon	Siyah	Krom	Altın
Code : 2058	128 - 160 mm	50	62,00	62,00	74,00
	192 - 224 mm	50	75,50	75,50	90,50

ZINC  
ALLOY

37



# LUX ZAMAK

Luxury Zinc Alloy



**Pelikan 50**

2059

T.T.No: 2023 / 006036



- Siyah
- Krom
- İnox
- Altın
- Rose
- Füme

Pelikan	ÖLÇÜ	Box	Siyah	Krom	İnox	Altın
Code : 2059	160 mm	50	52,00	62,00	66,96	68,00
	224 mm	50	59,00	74,00	79,92	82,00



**Penguen 50**

2060



- Siyah
- Krom
- İnox
- Altın
- Rose
- Füme

Penguen	ÖLÇÜ	Box	Siyah	Krom	İnox	Altın
Code : 2060	128 mm	50	51,00	59,50	64,26	67,00
	160 mm	50	58,00	68,00	73,44	74,00
	224 mm	50	68,00	83,50	90,18	91,00

ZINC  
ALLOY

38





50

## Alperen

2061

- Siyah ●
- Krom ●
- İnox ●
- Altın ●
- Rose ●
- Füme ●



### Alperen

Code : 2061

ÖLÇÜ	İkon	Siyah	Krom	İnox	Altın
96 mm	50	37,50	46,00	49,68	50,00
128 mm	50	42,00	50,50	54,54	58,00
160 mm	50	47,00	58,00	62,64	64,00
224 mm	50	53,50	69,00	74,52	77,00



50

## Ovit

2062

T.T.No: 2017 / 00430

- Siyah ●
- Krom ●
- İnox ●
- Altın ●
- Rose ●
- Füme ●



### Ovit

Code : 2062

ÖLÇÜ	İkon	Siyah	Krom	İnox	Altın
128 mm	50	40,00	40,00	43,20	55,00
160 mm	50	54,50	54,50	58,86	60,00

ZINC  
ALLOY

39



# LUX ZAMAK

Luxury Zinc Alloy

DEĞİŞİM



**Sırma** 50

2063

T.T.No: 2016 / 05434

- Siyah
- Krom
- İnox
- Altın
- Rose
- Füme



**Sırma**

**ÖLÇÜ**



**Siyah**

**Krom**

**Altın**

Code : 2063

160 mm

50

65,00

65,00

71,00



**İnci** 50

2064

T.T.No: 2020 / 02195

- Siyah
- Krom
- İnox
- Altın
- Rose
- Füme



**İnci**

**ÖLÇÜ**



**Siyah**

**Krom**

**İnox**

**Altın**

Code : 2064

128 mm

50

36,00

45,00

48,60

53,00

160 mm

50

40,50

51,50

55,62

57,54

ZINC  
ALLOY

40





50

**Efes**

Siyah ●

2065

Krom ●

T.T.No: 2016 / 05795

İnox ●

Altın ●

Rose ●

Füme ●



Efes	ÖLÇÜ	İkon	Siyah	Krom	Altın
Code : 2065	160 mm	50	61,00	61,00	67,00



50

**Lilyum**

Siyah ●

2066

Krom ●

T.T.No: 2016 / 05680

İnox ●

Altın ●

Rose ●

Füme ●



Lilyum	ÖLÇÜ	İkon	Siyah	Krom	Altın
Code : 2066	160 mm	50	61,00	61,00	67,00

ZINC  
ALLOY

41



# LUX ZAMAK

Luxury Zinc Alloy



## Çizgili Topuz

50

2067



- Siyah
- Krom
- İnox
- Altın
- Rose
- Füme

### Çizgili Topuz

Code : 2067

ÖLÇÜ		Siyah	Krom	Altın
160 mm	50	86,00	92,00	102,00
224 mm	50	96,50	105,50	115,00



## Sütun

50

2068

T.T.No: 2019 / 00709



- Siyah
- Krom
- İnox
- Altın
- Rose
- Füme

### Sütun

Code : 2068

ÖLÇÜ		Siyah	Krom	Altın
128 mm	50	52,50	60,50	68,00
160 mm	50	58,00	68,50	74,50
224 mm	50	68,00	82,00	89,50

ZINC  
ALLOY

42





50

**Oval  
Gölcük**

2069

T.T.No: 2016 / 05795

Siyah ●

Krom ●

Inox ●

Altın ●

Rose ●

Füme ●

**Oval Gölcük**

Code : 2069

ÖLÇÜ	Box	Siyah	Krom	Inox	Altın
128 mm	50	36,00	45,00	48,60	52,50
160 mm	50	40,00	52,00	56,16	57,50
224 mm	50	47,50	64,00	69,12	71,50



50

**Kare  
Lama**

2070

T.T.No: 2022 / 010473

Siyah ●

Krom ●

Inox ●

Altın ●

Rose ●

Füme ●

**Kare Lama**

Code : 2070

ÖLÇÜ	Box	Siyah	Krom	Altın
128 mm	50	54,00	62,00	69,50
160 mm	50	61,00	71,00	77,00

 ZINC  
ALLOY

43



# LUX ZAMAK

Luxury Zinc Alloy

DEĞİŞİM

Oval  
Lama



50

2071

T.T.No: 2022 / 010473



- Siyah
- Krom
- İnox
- Altın
- Rose
- Füme

Oval Lama

Code : 2071

ÖLÇÜ	İkon	Siyah	Krom	Altın
128 mm	50	54,00	62,00	69,50
160 mm	50	61,00	71,00	77,00

Zümre



50

2072



- Siyah
- Krom
- İnox
- Altın
- Rose
- Füme

Zümre

Code : 2072

ÖLÇÜ	İkon	Siyah	Krom	İnox	Altın
96 mm	50	46,00	53,50	57,78	58,00
128 mm	50	54,00	62,00	66,96	69,50
160 mm	50	61,00	71,00	76,68	77,00

ZINC  
ALLOY

44





50 Met

- Siyah ● 2073
- Krom ●
- İnox ●
- Altın ●
- Rose ●
- Füme ●



Met	ÖLÇÜ	İkon	Siyah	Krom	İnox	Altın
Code : 2073	96 mm	50	35,00	43,50	46,98	48,50
	128 mm	50	42,50	51,50	55,62	58,50



50 Can

- Siyah ● 2074
- Krom ● T.T.No: 2023 / 006036
- İnox ●
- Altın ●
- Rose ●
- Füme ●



Can	ÖLÇÜ	İkon	Siyah	Krom	Altın
Code : 2074	128 mm	50	54,00	62,00	69,50
	160 mm	50	61,00	71,00	77,00

ZINC  
ALLOY

45



# LUX ZAMAK

Luxury Zinc Alloy

DEĞİŞİM



**Kesit** 50

2075

T.T.No: 2017 / 00430



- Siyah
- Krom
- İnox
- Altın
- Rose
- Füme

Kesit	ÖLÇÜ	Box	Siyah	Krom	Altın
Code : 2075	160 mm	50	65,00	65,00	71,00



**Nal** 50

2076

T.T.No: 2023 / 001742



- Siyah
- Krom
- İnox
- Altın
- Rose
- Füme

Nal	ÖLÇÜ	Box	Siyah	Krom	İnox	Altın
Code : 2076	128 mm	50	68,00	76,00	82,08	88,00
	160 mm	50	78,00	87,00	93,96	93,50

ZINC  
ALLOY

46





# *Eko Seri / Zamak*

Değişim Furniture Accessories, Zarif Tasarımlı Eko Serisi Zamak Ürünleriyle Ofis Mobilyalarınıza Şıklık Katar.

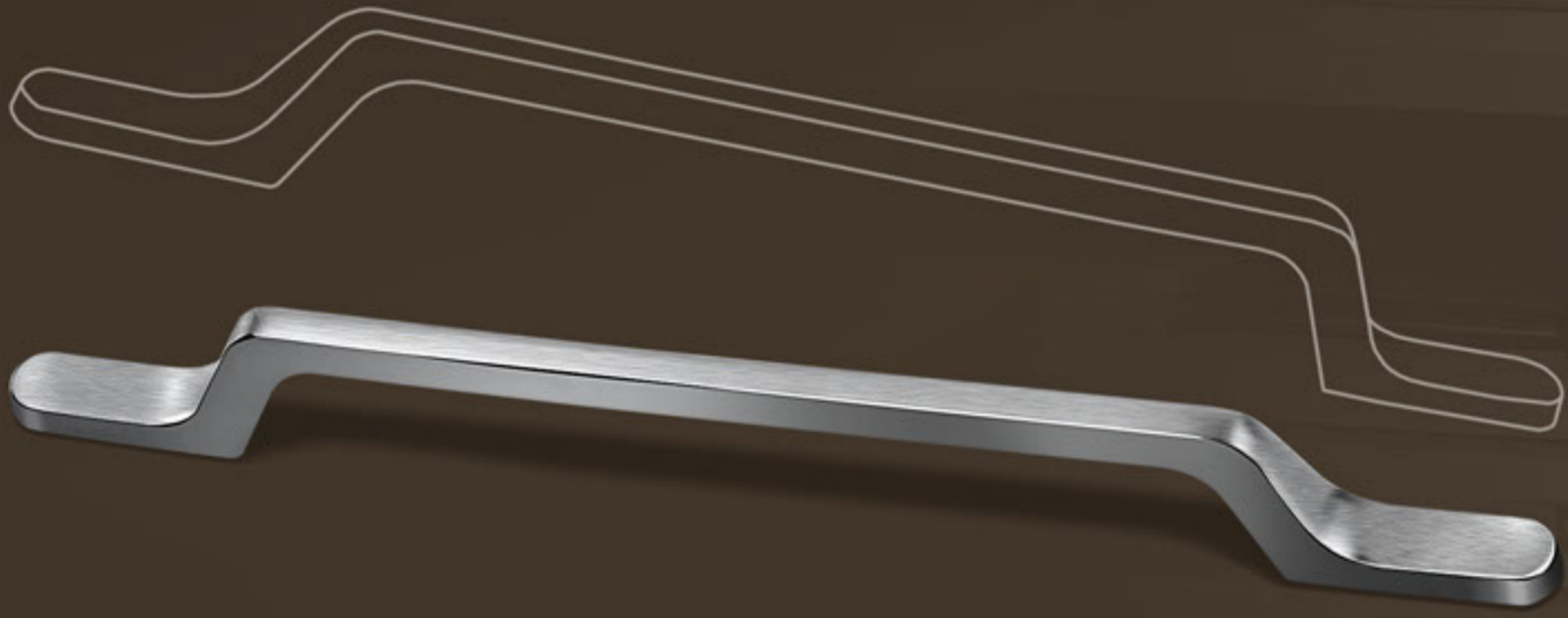

96mm / 128mm / 160mm Ölçülerinde Karden Eko Zamak Serisi Kulp Siyah - Krom - İnox - Altın ve Daha Birçok Renk Seçenekleriyle Ofis Mobilyalarınıza Şıklık Katar.





**New Model**  
Karden







**50 Petek**

2077

- Siyah ●
- Krom ●
- Inox ●
- Altın ●
- Rose ●
- Füme ●



**Petek**

Code : 2077

**ÖLÇÜ**



**RENKLER**

96 mm

50

Siyah - Krom

128 mm

50

Antik - Altın

160 mm

50

224 mm

50



**50 Yayık**

2078

T.T.No: 2023 / 001742

- Siyah ●
- Krom ●
- Inox ●
- Altın ●
- Rose ●
- Füme ●



**Yayık**

Code : 2078

**ÖLÇÜ**



**RENKLER**

128 mm

50

Siyah - Krom

160 mm

50

Antik - Altın

ECO  
ZINC  
ALLOY

47



# EKO ZAMAK

Eco Zinc Alloy

DEĞİŞİM



Akasya  
Düz



50

2079

- Siyah
- Krom
- İnox
- Altın
- Rose
- Füme



Akasya Düz / Çizgili / Desenli

Code : 2079

ÖLÇÜ



RENKLER

128 mm

50

Siyah - Krom

160 mm

50

224 mm

50



Alize



50

2080

- Siyah
- Krom
- İnox
- Altın
- Rose
- Füme



Alize Düz / Alize Çizgili

Code : 2080

ÖLÇÜ



RENKLER

128 mm

50

Siyah - Krom

ECO  
ZINC  
ALLOY

48





50

### Ayaklı Noktalı

2081

Siyah ●

Krom ●

Inox ●

Altın ●

Rose ●

Füme ●



#### Ayaklı Noktalı

Code : 2081

#### ÖLÇÜ

96 mm



50

#### RENKLER

Siyah - Krom

M.Krom - Saten



50

### Baklavalı

2082

Siyah ●

Krom ●

Inox ●

Altın ●

Rose ●

Füme ●



#### Baklavalı

Code : 2082

#### ÖLÇÜ

96 mm



50

#### RENKLER

Siyah - Krom

M.Krom - Saten



50

### Çift Baklavalı

2083

Siyah ●

Krom ●

Inox ●

Altın ●

Rose ●

Füme ●



#### Çift Baklavalı

Code : 2083

#### ÖLÇÜ

96 mm



50

#### RENKLER

Siyah - Krom

M.Krom - Saten

ECO  
ZINC  
ALLOY

49



# EKO ZAMAK

Eco Zinc Alloy



**Noktalı** 50

2084



- Siyah
- Krom
- İnox
- Altın
- Rose
- Füme

**Noktalı**

Code : 2084

**ÖLÇÜ**

96 mm



50

**RENKLER**

Siyah - Krom  
M.Krom - Saten



**Elif** 50

2085



- Siyah
- Krom
- İnox
- Altın
- Rose
- Füme

**Elif**

Code : 2085

**ÖLÇÜ**

128 mm

160 mm

192 mm



50

50

50

**RENKLER**

Siyah - Krom



**Dilara** 50

2086



- Siyah
- Krom
- İnox
- Altın
- Rose
- Füme

**Dilara**

Code : 2086

**ÖLÇÜ**

128 mm



50

**RENKLER**

Siyah - Krom

ECO  
ZINC  
ALLOY

50



**50 Düz**

2087

- Siyah ●
- Krom ●
- Inox ●
- Altın ●
- Rose ●
- Füme ●



Düz	ÖLÇÜ		RENKLER
Code : 2087	96 mm	50	Siyah - Krom M.Krom - Saten

**50 Kılıç**

2088

- Siyah ●
- Krom ●
- Inox ●
- Altın ●
- Rose ●
- Füme ●



Kılıç	ÖLÇÜ		RENKLER
Code : 2088	128 mm	50	Siyah - Krom
	160 mm	50	

**50 Sülün**

2089

- Siyah ●
- Krom ●
- Inox ●
- Altın ●
- Rose ●
- Füme ●



Sülün	ÖLÇÜ		RENKLER
Code : 2089	96 mm	50	Siyah - Krom M.Krom - Saten

 ECO  
 ZINC  
 ALLOY

51



# EKO ZAMAK

Eco Zinc Alloy

DEĞİŞİM



Nil 50



2090

- Siyah
- Krom
- İnox
- Altın
- Rose
- Füme

Nil	ÖLÇÜ	Box	RENKLER
Code : 2090	96 mm	50	Siyah - Krom
	128 mm	50	Saten



Bihter Desenli 50

2091

- Siyah
- Krom
- İnox
- Altın
- Rose
- Füme

Bihter Desenli	ÖLÇÜ	Box	RENKLER
Code : 2091	128 mm	50	Siyah - Krom
	160 mm	50	Altın
	224 mm	50	



Vera 50

2092

- Siyah
- Krom
- İnox
- Altın
- Rose
- Füme

Vera	ÖLÇÜ	Box	RENKLER
Code : 2092	96 mm	50	Siyah - Krom
	128 mm	50	Altın

ECO  
ZINC  
ALLOY

52



**50 Yalı**

2093

- Siyah ●
- Krom ●
- İnox ●
- Altın ●
- Rose ●
- Füme ●

**Yalı**

Code : 2093

**ÖLÇÜ**

**RENKLER**

128 mm

50

Siyah - Krom

160 mm

50

**50 Noktalı Yalı**

2094

- Siyah ●
- Krom ●
- İnox ●
- Altın ●
- Rose ●
- Füme ●

**Noktalı Yalı**

Code : 2094

**ÖLÇÜ**

**RENKLER**

128 mm

50

Siyah - Krom

160 mm

50

**50 Siena**

2095

- Siyah ●
- Krom ●
- İnox ●
- Altın ●
- Rose ●
- Füme ●

**Siena**

Code : 2095

**ÖLÇÜ**

**RENKLER**

128 mm

50

Siyah - Krom

160 mm

50

M.Krom - İnox

192 mm

50

224 mm

50

 ECO  
 ZINC  
 ALLOY

53



# EKO ZAMAK

Eco Zinc Alloy

DEĞİŞİM



Motif 50

2096

- Siyah
- Krom
- İnox
- Altın
- Rose
- Füme

## Motif

Code : 2096

## ÖLÇÜ

96 mm  
128 mm



50  
50

## RENKLER

Siyah - Krom  
M.Krom



Eko Oval 50

2097

- Siyah
- Krom
- İnox
- Altın
- Rose
- Füme

## Eko Oval

Code : 2097

## ÖLÇÜ

96 mm  
128 mm  
160 mm



50  
50  
50

## RENKLER

Siyah - Krom  
M.Krom - İnox



Yeni Ördek 50

2098

- Siyah
- Krom
- İnox
- Altın
- Rose
- Füme

## Ördek

Code : 2098

## ÖLÇÜ

96 mm  
128 mm



50  
50

## RENKLER

Siyah - Krom  
Saten - M.Krom

ECO  
ZINC  
ALLOY

54





# *Aluminyum*

Hafif ve Dayanıklı Aluminyum Mobilya Kulpları Estetik Görünümlü Mutfak Dolabı Projeleriniz İçin Titizlikle Üretilir.

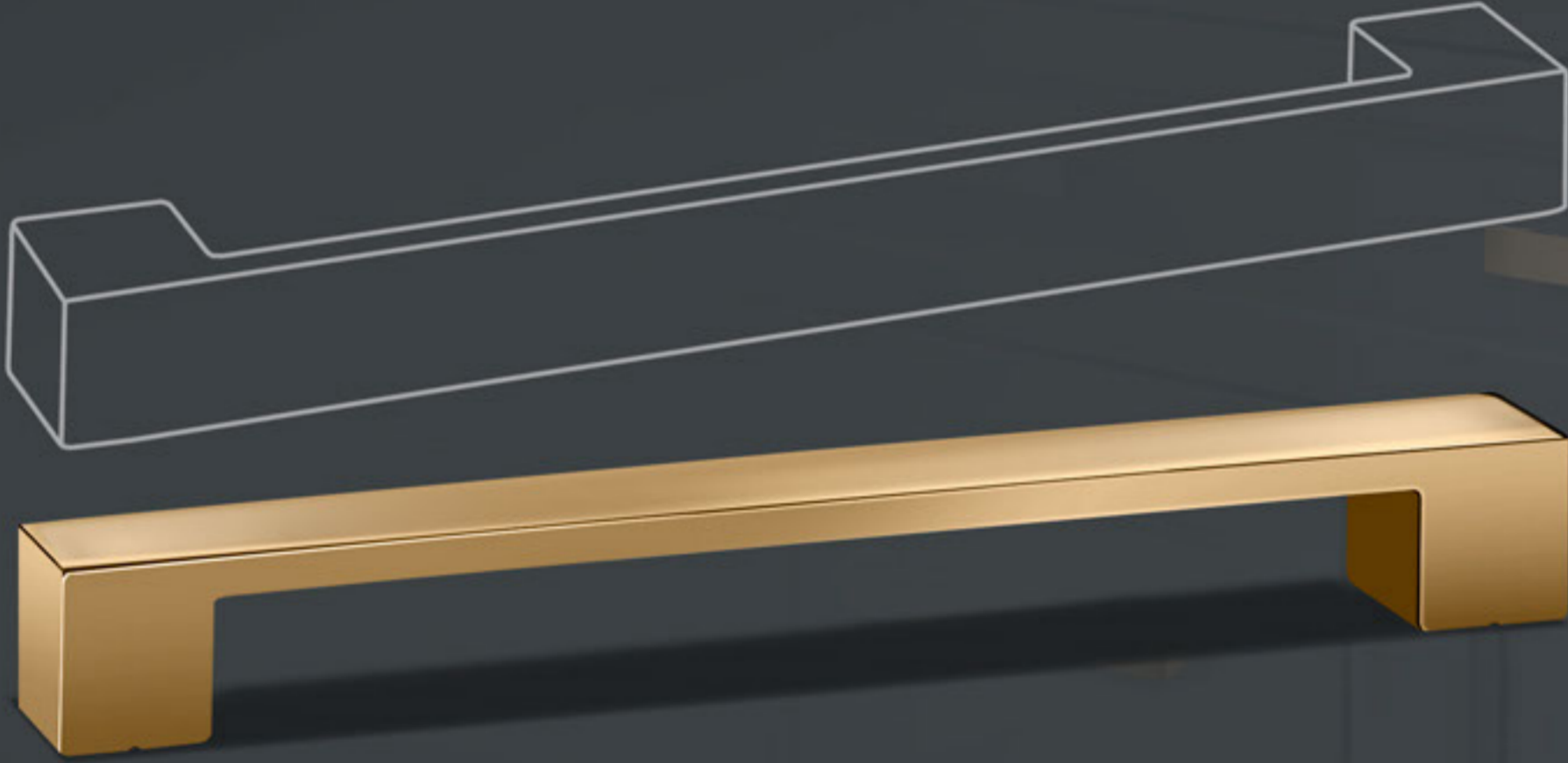

18mm / 20mm / 25mm Malzeme Ölçülerinde Efsane Aluminyum Kulp Serisi, Siyah - Krom - İnox - Altın ve Daha Birçok Renk Seçenekleriyle Estetik Mutfak Mobilyaları İçin Titizlikle Üretilir.





**New Model**  
Efsane





**50 Kemer**

- Siyah ●
- Krom ●
- İnox ●
- Altın ●
- Rose ●
- Füme ●

**1071**

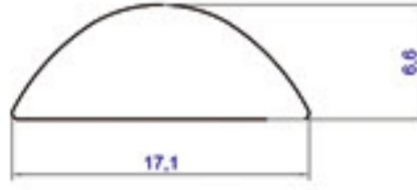

Kemer	ÖLÇÜ		Siyah	Krom	İnox	Altın
Code : 1071 7 x 18	128 mm	50	28,22	28,22	30,47	35,04
	160 mm	50	32,50	32,50	35,10	40,36
	192 mm	50	36,97	36,97	39,93	45,92
	224 mm	50	41,72	41,72	45,06	51,82
	256 mm	50	47,15	47,15	50,92	58,56
	288 mm	50	52,27	52,27	56,46	64,93
	320 mm	50	57,95	57,95	62,58	71,97

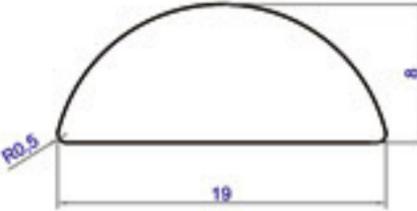

Lüks Kemer	ÖLÇÜ		Siyah	Krom	İnox	Altın
Code : 1071 - 1 8 x 19	128 mm	50	36,53	36,53	39,45	45,37
	160 mm	50	42,70	42,70	46,11	53,03
	192 mm	50	49,60	49,60	53,57	61,61
	224 mm	50	56,91	56,91	61,46	70,68
	256 mm	50	65,84	65,84	71,11	81,78
	288 mm	50	73,44	73,44	79,31	91,21
	320 mm	50	81,75	81,75	88,29	101,54

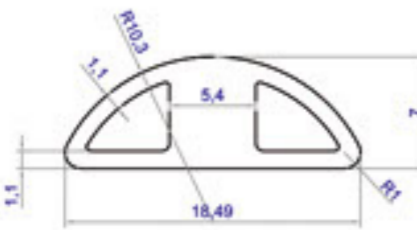

Boş Kemer	ÖLÇÜ		Siyah	Krom	İnox	Altın
Code : 1081 18.50 x 7	128 mm	50	26,15	26,15	28,25	32,48
	160 mm	50	29,87	29,87	32,26	37,10
	192 mm	50	33,93	33,93	36,65	42,14
	224 mm	50	38,20	38,20	41,25	47,44
	256 mm	50	43,07	43,07	46,52	53,50
	288 mm	50	47,81	47,81	51,64	59,38
	320 mm	50	53,10	53,10	57,35	65,95





# ALUMİNYUM

## Aluminium



Şahin 50

1072



- Siyah
- Krom
- İnox
- Altın
- Rose
- Füme

Şahin	ÖLÇÜ		Siyah	Krom	İnox	Altın
Code : 1072 7 x 18	128 mm	50	28,22	28,22	30,47	35,04
	160 mm	50	32,50	32,50	35,10	40,36
	192 mm	50	36,97	36,97	39,93	45,92
	224 mm	50	41,72	41,72	45,06	51,82
	256 mm	50	47,15	47,15	50,92	58,56
	288 mm	50	52,27	52,27	56,46	64,93
	320 mm	50	57,95	57,95	62,58	71,97

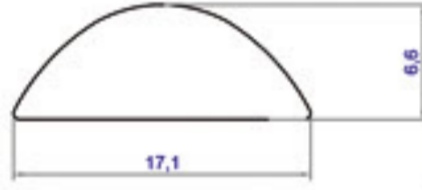

Lüks Şahin	ÖLÇÜ		Siyah	Krom	İnox	Altın
Code : 1072 - 1 8 x 19	128 mm	50	36,53	36,53	39,45	45,37
	160 mm	50	42,70	42,70	46,11	53,03
	192 mm	50	49,60	49,60	53,57	61,61
	224 mm	50	56,91	56,91	61,46	70,68
	256 mm	50	65,84	65,84	71,11	81,78
	288 mm	50	73,44	73,44	79,31	91,21
	320 mm	50	81,75	81,75	88,29	101,54

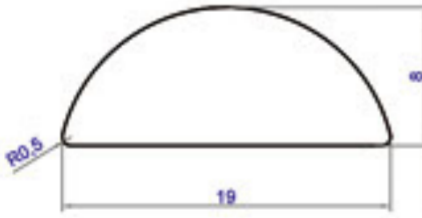

Boş Şahin	ÖLÇÜ		Siyah	Krom	İnox	Altın
Code : 1080 18.50 x 7	128 mm	50	26,15	26,15	28,25	32,48
	160 mm	50	29,87	29,87	32,26	37,10
	192 mm	50	33,93	33,93	36,65	42,14
	224 mm	50	38,20	38,20	41,25	47,44
	256 mm	50	43,07	43,07	46,52	53,50
	288 mm	50	47,81	47,81	51,64	59,38
	320 mm	50	53,10	53,10	57,35	65,95

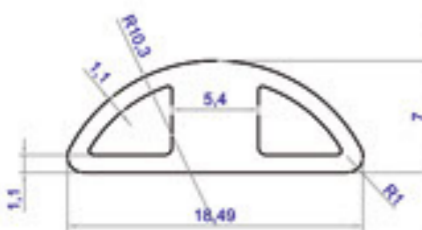

ALM

56



**50 Efe**

Siyah ●

Krom ●

İnox ●

Altın ●

Rose ●

Füme ●

**1074**



Efe	ÖLÇÜ		Siyah	Krom	İnox	Altın
<b>Code : 1074</b> <b>7 x 18</b>	128 mm	50	28,22	28,22	30,47	35,04
	160 mm	50	32,50	32,50	35,10	40,36
	192 mm	50	36,97	36,97	39,93	45,92
	224 mm	50	41,72	41,72	45,06	51,82
	256 mm	50	47,15	47,15	50,92	58,56
	288 mm	50	52,27	52,27	56,46	64,93
	320 mm	50	57,95	57,95	62,58	71,97

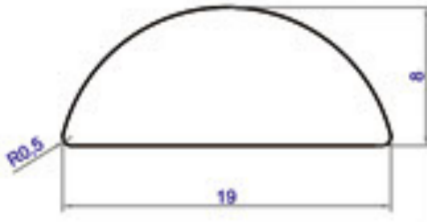

Lüks Efe	ÖLÇÜ		Siyah	Krom	İnox	Altın
<b>Code : 1074 - 1</b> <b>8 x 19</b>	128 mm	50	36,53	36,53	39,45	45,37
	160 mm	50	42,70	42,70	46,11	53,03
	192 mm	50	49,60	49,60	53,57	61,61
	224 mm	50	56,91	56,91	61,46	70,68
	256 mm	50	65,84	65,84	71,11	81,78
	288 mm	50	73,44	73,44	79,31	91,21
	320 mm	50	81,75	81,75	88,29	101,54

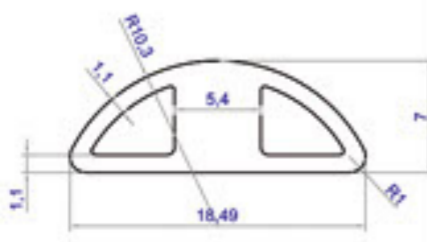

Boş Efe	ÖLÇÜ		Siyah	Krom	İnox	Altın
<b>Code : 1083</b> <b>18.50 x 7</b>	128 mm	50	26,15	26,15	28,25	32,48
	160 mm	50	29,87	29,87	32,26	37,10
	192 mm	50	33,93	33,93	36,65	42,14
	224 mm	50	38,20	38,20	41,25	47,44
	256 mm	50	43,07	43,07	46,52	53,50
	288 mm	50	47,81	47,81	51,64	59,38
	320 mm	50	53,10	53,10	57,35	65,95





# ALUMİNYUM

## Aluminium



**Kumru** 50  
**1073**

- Siyah
- Krom
- İnox
- Altın
- Rose
- Füme

Kumru	ÖLÇÜ	Box	Siyah	Krom	İnox	Altın
Code : 1073 7 x 18	128 mm	50	28,22	28,22	30,47	35,04
	160 mm	50	32,50	32,50	35,10	40,36
	192 mm	50	36,97	36,97	39,93	45,92
	224 mm	50	41,72	41,72	45,06	51,82
	256 mm	50	47,15	47,15	50,92	58,56
	288 mm	50	52,27	52,27	56,46	64,93
	320 mm	50	57,95	57,95	62,58	71,97



Lüks Kumru	ÖLÇÜ	Box	Siyah	Krom	İnox	Altın
Code : 1073-1 8 x 19	128 mm	50	36,53	36,53	39,45	45,37
	160 mm	50	42,70	42,70	46,11	53,03
	192 mm	50	49,60	49,60	53,57	61,61
	224 mm	50	56,91	56,91	61,46	70,68
	256 mm	50	65,84	65,84	71,11	81,78
	288 mm	50	73,44	73,44	79,31	91,21
	320 mm	50	81,75	81,75	88,29	101,54

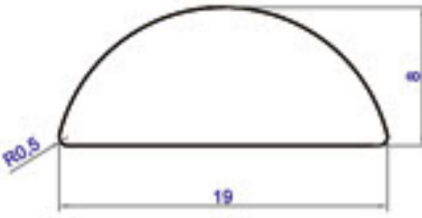

Boş Kumru	ÖLÇÜ	Box	Siyah	Krom	İnox	Altın
Code : 1082 18.50 x 7	128 mm	50	26,15	26,15	28,25	32,48
	160 mm	50	29,87	29,87	32,26	37,10
	192 mm	50	33,93	33,93	36,65	42,14
	224 mm	50	38,20	38,20	41,25	47,44
	256 mm	50	43,07	43,07	46,52	53,50
	288 mm	50	47,81	47,81	51,64	59,38
	320 mm	50	53,10	53,10	57,35	65,95

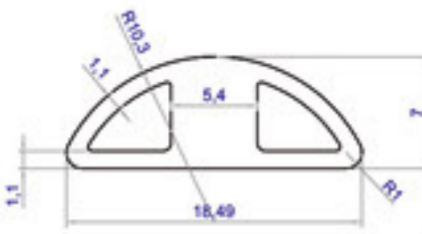

ALM

58





**50 Safran**
**1076**

- Siyah ●
- Krom ●
- İnox ●
- Altın ●
- Rose ●
- Füme ●

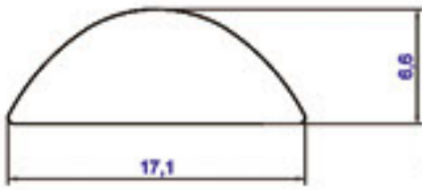

Safran	ÖLÇÜ		Siyah	Krom	İnox	Altın
Code : 1076	128 mm	50	29,72	29,72	32,09	36,91
	160 mm	50	33,75	33,75	36,45	41,92
7 x 18	192 mm	50	38,06	38,06	41,10	47,27
	224 mm	50	42,64	42,64	46,05	52,96
	256 mm	50	47,90	47,90	51,73	59,49
	288 mm	50	53,03	53,03	57,27	65,86
	320 mm	50	58,70	58,70	63,39	72,90



Lüks Safran	ÖLÇÜ		Siyah	Krom	İnox	Altın
Code : 1076 - 1	128 mm	50	38,31	38,31	41,38	47,59
	160 mm	50	44,12	44,12	47,65	54,80
8 x 19	192 mm	50	50,79	50,79	54,85	63,08
	224 mm	50	57,74	57,74	62,36	71,72
	256 mm	50	66,56	66,56	71,88	82,66
	288 mm	50	73,80	73,80	79,70	91,65
	320 mm	50	82,47	82,47	89,06	102,42

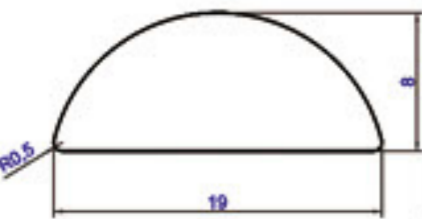





Papatya 50

1077

- Siyah
- Krom
- İnox
- Altın
- Rose
- Füme



Papatya	ÖLÇÜ	İkon	Siyah	Krom	İnox	Altın
Code : 1077 7 x 18	128 mm	50	29,72	29,72	32,09	36,91
	160 mm	50	33,75	33,75	36,45	41,92
	192 mm	50	38,06	38,06	41,10	47,27
	224 mm	50	42,64	42,64	46,05	52,96
	256 mm	50	47,90	47,90	51,73	59,49
	288 mm	50	53,03	53,03	57,27	65,86
	320 mm	50	58,70	58,70	63,39	72,90

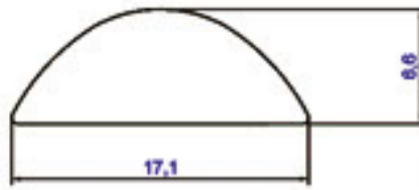

Lüks Papatya	ÖLÇÜ	İkon	Siyah	Krom	İnox	Altın
Code : 1077 - 1 8 x 19	128 mm	50	38,31	38,31	41,38	47,59
	160 mm	50	44,12	44,12	47,65	54,80
	192 mm	50	50,79	50,79	54,85	63,08
	224 mm	50	57,74	57,74	62,36	71,72
	256 mm	50	66,56	66,56	71,88	82,66
	288 mm	50	73,80	73,80	79,70	91,65
	320 mm	50	82,47	82,47	89,06	102,42

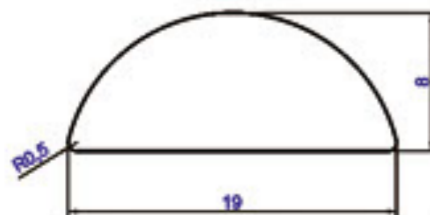

ALM

60





### 50 Feza

- 1075
- Siyah ●
  - Krom ●
  - İnox ●
  - Altın ●
  - Rose ●
  - Füme ●



Feza	ÖLÇÜ		Siyah	Krom	İnox	Altın
Code : 1075 7 x 18	128 mm	50	28,22	28,22	30,47	35,04
	160 mm	50	32,50	32,50	35,10	40,36
	192 mm	50	36,97	36,97	39,93	45,92
	224 mm	50	41,72	41,72	45,06	51,82
	256 mm	50	47,15	47,15	50,92	58,56
	288 mm	50	52,27	52,27	56,46	64,93
	320 mm	50	57,95	57,95	62,58	71,97

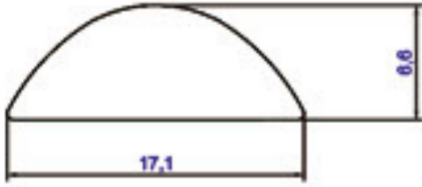

Lüks Feza	ÖLÇÜ		Siyah	Krom	İnox	Altın
Code : 1075 - 1 8 x 19	128 mm	50	36,53	36,53	39,45	45,37
	160 mm	50	42,70	42,70	46,11	53,03
	192 mm	50	49,60	49,60	53,57	61,61
	224 mm	50	56,91	56,91	61,46	70,68
	256 mm	50	65,84	65,84	71,11	81,78
	288 mm	50	73,44	73,44	79,31	91,21
	320 mm	50	81,75	81,75	88,29	101,54

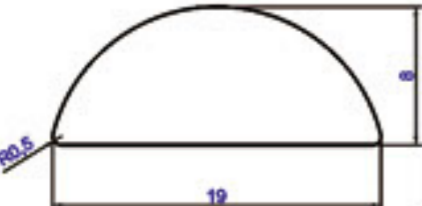



Şahin  
Şeritli

50

1078

- Siyah
- Krom
- İnox
- Altın
- Rose
- Füme



## Şahin Şeritli

Code : 1078

7 x 18

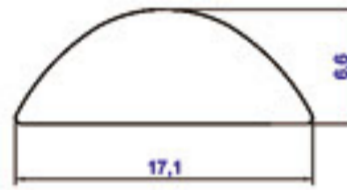

ÖLÇÜ		Krom İnox
128 mm	50	41,96
160 mm	50	47,93
192 mm	50	54,30
224 mm	50	61,07
256 mm	50	68,85
288 mm	50	76,43
320 mm	50	84,81

## Lüks Şahin Şeritli

Code : 1078 - 1

8 x 19

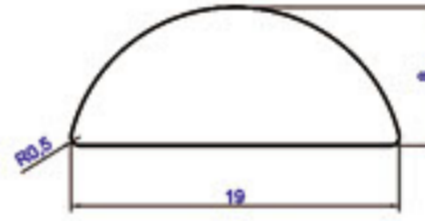

ÖLÇÜ		Krom İnox
128 mm	50	51,89
160 mm	50	60,09
192 mm	50	69,50
224 mm	50	79,32
256 mm	50	91,75
288 mm	50	101,97
320 mm	50	114,21

Eko  
Şahin

50

1077

- Siyah
- Krom
- İnox
- Altın
- Rose
- Füme

## Eko Şahin

Code : 1087

7 x 14

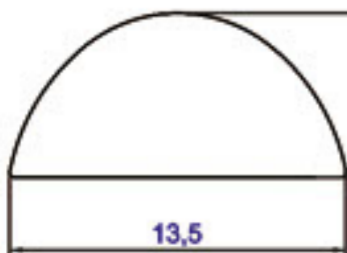

ÖLÇÜ		Siyah	Krom	İnox	Altın
128 mm	50	25,22	25,22	27,24	31,33
160 mm	50	28,78	28,78	31,08	35,74
192 mm	50	32,34	32,34	34,92	40,16
224 mm	50	36,71	36,71	39,65	45,60
256 mm	50	41,50	41,50	44,82	51,54
288 mm	50	46,15	46,15	49,84	57,31
320 mm	50	51,34	51,34	55,45	63,77

ALM

62



**50**
**Eko Kemer**
**1086**

Siyah ●

Krom ●

İnox ●

Altın ●

Rose ●

Füme ●

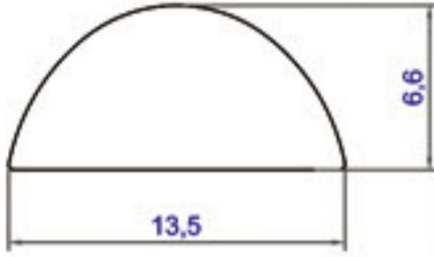

Eko Kemer	ÖLÇÜ		Siyah	Krom	İnox	Altın
Code : 1086	128 mm	50	25,22	25,22	27,24	31,33
	160 mm	50	28,78	28,78	31,08	35,74
7 x 14	192 mm	50	32,34	32,34	34,92	40,16
	224 mm	50	36,71	36,71	39,65	45,60
	256 mm	50	41,50	41,50	44,82	51,54
	288 mm	50	46,15	46,15	49,84	57,31
	320 mm	50	51,34	51,34	55,45	63,77

**50**
**Eko Efe**
**1088**

Siyah ●

Krom ●

İnox ●

Altın ●

Rose ●

Füme ●

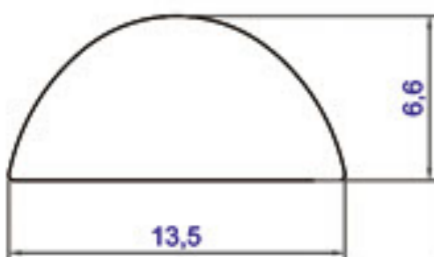

Eko Efe	ÖLÇÜ		Siyah	Krom	İnox	Altın
Code : 1088	128 mm	50	25,22	25,22	27,24	31,33
	160 mm	50	28,78	28,78	31,08	35,74
7 x 14	192 mm	50	32,34	32,34	34,92	40,16
	224 mm	50	36,71	36,71	39,65	45,60
	256 mm	50	41,50	41,50	44,82	51,54
	288 mm	50	46,15	46,15	49,84	57,31
	320 mm	50	51,34	51,34	55,45	63,77

**ALM**
**63**



# ALUMİNYUM

Aluminium

DEĞİŞİM



Eko  
Kumru



50

1089

- Siyah
- Krom
- İnox
- Altın
- Rose
- Füme



Eko Kumru	ÖLÇÜ	İkon	Siyah	Krom	İnox	Altın
Code : 1089	128 mm	50	25,22	25,22	27,24	31,33
	160 mm	50	28,78	28,78	31,08	35,74
7 x 14	192 mm	50	32,34	32,34	34,92	40,16
	224 mm	50	36,71	36,71	39,65	45,60
	256 mm	50	41,50	41,50	44,82	51,54
	288 mm	50	46,15	46,15	49,84	57,31
	320 mm	50	51,34	51,34	55,45	63,77

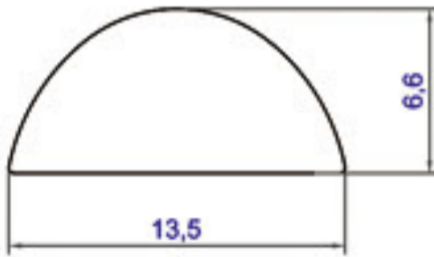

Eko  
Feza



50

1090

- Siyah
- Krom
- İnox
- Altın
- Rose
- Füme

Eko Feza	ÖLÇÜ	İkon	Siyah	Krom	İnox	Altın
Code : 1090	128 mm	50	25,22	25,22	27,24	31,33
	160 mm	50	28,78	28,78	31,08	35,74
7 x 14	192 mm	50	32,34	32,34	34,92	40,16
	224 mm	50	36,71	36,71	39,65	45,60
	256 mm	50	41,50	41,50	44,82	51,54
	288 mm	50	46,15	46,15	49,84	57,31
	320 mm	50	51,34	51,34	55,45	63,77

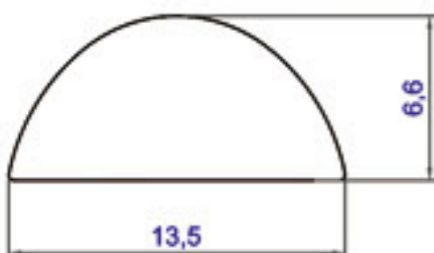

ALM

64





50

**Eko  
Safran**

1091

Siyah ●

Krom ●

İnox ●

Altın ●

Rose ●

Füme ●



**Eko Safran**

**ÖLÇÜ**



**Siyah**

**Krom**

**İnox**

**Altın**

Code : 1091

128 mm

50

26,32

26,32

28,42

32,69

7 x 14

160 mm

50

29,88

29,88

32,27

37,11

192 mm

50

33,43

33,43

36,11

41,52

224 mm

50

37,81

37,81

40,83

46,96

256 mm

50

42,59

42,59

46,00

52,90

288 mm

50

47,24

47,24

51,02

58,68

320 mm

50

52,44

52,44

56,63

65,13

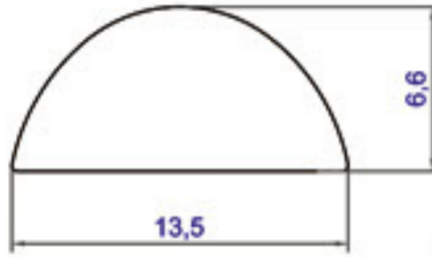

50

**Eko  
Papatya**

1092

Siyah ●

Krom ●

İnox ●

Altın ●

Rose ●

Füme ●



**Eko Papatya**

**ÖLÇÜ**



**Siyah**

**Krom**

**İnox**

**Altın**

Code : 1092

128 mm

50

26,32

26,32

28,42

32,69

7 x 14

160 mm

50

29,88

29,88

32,27

37,11

192 mm

50

33,43

33,43

36,11

41,52

224 mm

50

37,81

37,81

40,83

46,96

256 mm

50

42,59

42,59

46,00

52,90

288 mm

50

47,24

47,24

51,02

58,68

320 mm

50

52,44

52,44

56,63

65,13

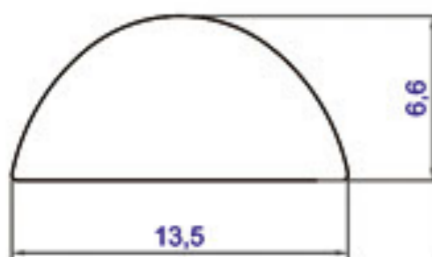

ALM

65





**Prizma** 50  
1093

- Siyah
- Krom
- İnox
- Altın
- Rose
- Füme

Prizma	ÖLÇÜ		Siyah	Krom	İnox	Altın
Code : 1093 6,5 x 16	128 mm	50	32,51	32,51	35,11	40,37
	160 mm	50	37,64	37,64	40,65	46,75
	192 mm	50	42,78	42,78	46,20	53,13
	224 mm	50	48,73	48,73	52,63	60,53
	256 mm	50	55,37	55,37	59,80	68,77
	288 mm	50	61,60	61,60	66,53	76,51
	320 mm	50	68,38	68,38	73,85	84,92

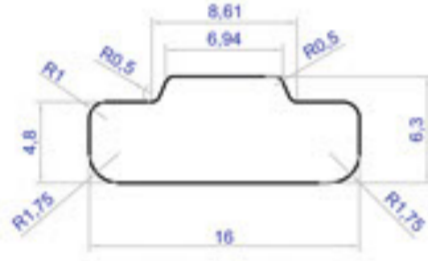

**Prizma** 50  
**Yay** 50  
1095

- Siyah
- Krom
- İnox
- Altın
- Rose
- Füme

Prizma Yay	ÖLÇÜ		Siyah	Krom	İnox	Altın
Code : 1095 6,5 x 16	128 mm	50	32,51	32,51	35,11	40,37
	160 mm	50	37,64	37,64	40,65	46,75
	192 mm	50	42,78	42,78	46,20	53,13
	224 mm	50	48,73	48,73	52,63	60,53
	256 mm	50	55,37	55,37	59,80	68,77
	288 mm	50	61,60	61,60	66,53	76,51
	320 mm	50	68,38	68,38	73,85	84,92

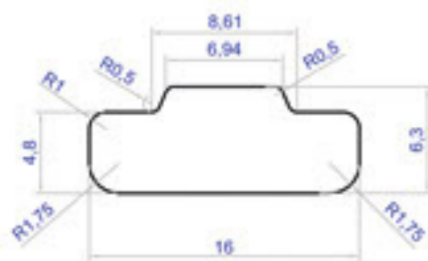

ALM

66



**50**
**Prizma Safran**
**1096**

Siyah ●

Krom ●

İnox ●

Altın ●

Rose ●

Füme ●

**Prizma Safran**
**ÖLÇÜ**

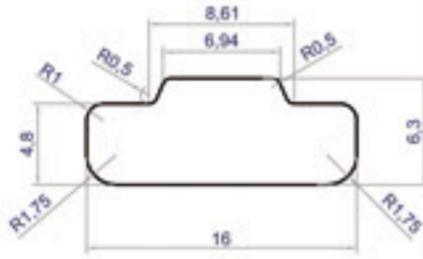
**Siyah**
**Krom**
**İnox**
**Altın**
**Code : 1096**
**6,5 x 16**

**128 mm**
**50**

33,52

33,52

36,20

41,63

**160 mm**
**50**

38,66

38,66

41,75

48,01

**192 mm**
**50**

43,79

43,79

47,30

54,39

**224 mm**
**50**

49,75

49,75

53,73

61,79

**256 mm**
**50**

56,39

56,39

60,90

70,03

**288 mm**
**50**

62,62

62,62

67,63

77,77

**320 mm**
**50**

69,39

69,39

74,94

86,18

**50**
**Ceyhan**
**1094**

Siyah ●

Krom ●

İnox ●

Altın ●

Rose ●

Füme ●

**Ceyhan**
**ÖLÇÜ**

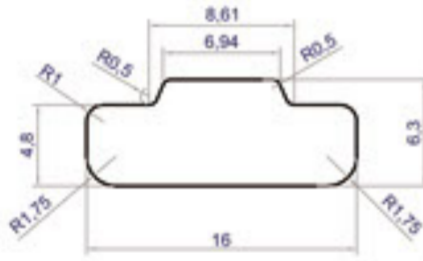
**Siyah**
**Krom**
**İnox**
**Altın**
**Code : 1094**
**6,5 x 16**

**128 mm**
**50**

32,51

32,51

35,11

40,37

**160 mm**
**50**

37,64

37,64

40,65

46,75

**192 mm**
**50**

42,78

42,78

46,20

53,13

**224 mm**
**50**

48,73

48,73

52,63

60,53

**256 mm**
**50**

55,37

55,37

59,80

68,77

**288 mm**
**50**

61,60

61,60

66,53

76,51

**320 mm**
**50**

68,38

68,38

73,85

84,92

**50**
**Gediz**
**1097**

Siyah ●

Krom ●

İnox ●

Altın ●

Rose ●

Füme ●

**Gediz**
**ÖLÇÜ**

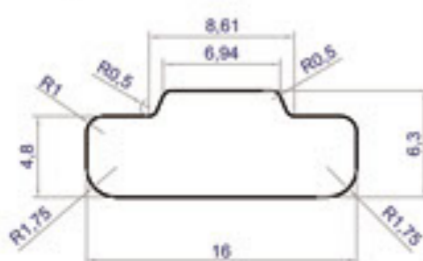
**Siyah**
**Krom**
**İnox**
**Altın**
**Code : 1097**
**6,5 x 16**

**128 mm**
**50**

51,92

51,92

56,07

64,48

**160 mm**
**50**

58,03

58,03

62,67

72,07

**192 mm**
**50**

64,15

64,15

69,28

79,67

**224 mm**
**50**

71,24

71,24

76,94

88,48

**256 mm**
**50**

79,14

79,14

85,47

98,29

**288 mm**
**50**

86,55

86,55

93,48

107,50

**320 mm**
**50**

94,62

94,62

102,19

117,52

**ALM**
**67**





Balabadi



50

1098

● Siyah

● Krom

● İnox

● Altın

● Rose

● Füme

## Balabadi

Code : 1098

10 x 12

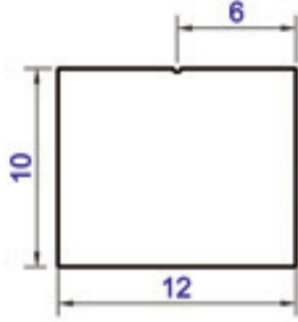

ÖLÇÜ	İkon	Siyah	Krom	İnox	Altın
128 mm	50	39,24	39,24	42,38	48,74
160 mm	50	45,74	45,74	49,40	56,81
192 mm	50	52,53	52,53	56,73	65,24
224 mm	50	60,17	60,17	64,99	74,73
256 mm	50	69,10	69,10	74,63	81,83
288 mm	50	77,61	77,61	83,81	96,39
320 mm	50	86,11	86,11	93,00	106,95

## Eko Balabadi

Code : 1103 - 1

7 x 12

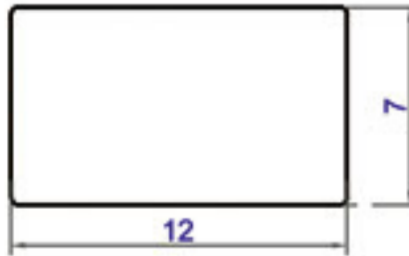

ÖLÇÜ	İkon	Siyah	Krom	İnox	Altın
128 mm	50	31,28	31,28	33,78	38,85
160 mm	50	36,13	36,13	39,02	44,88
192 mm	50	40,98	40,98	44,26	50,90
224 mm	50	46,66	46,66	50,39	57,95
256 mm	50	53,01	53,01	57,25	65,84
288 mm	50	58,96	58,96	63,67	73,22
320 mm	50	65,45	65,45	70,68	81,28

## Milano

Code : 1103

10 x 10

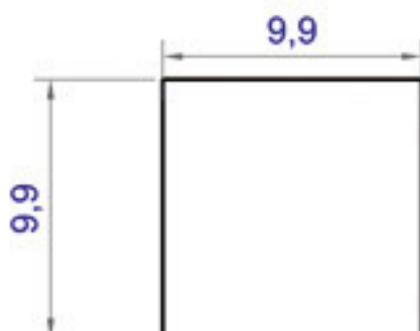

ÖLÇÜ	İkon	Siyah	Krom	İnox	Altın
128 mm	50	35,72	35,72	38,58	44,37
160 mm	50	41,40	41,40	44,72	51,42
192 mm	50	47,08	47,08	50,85	58,48
224 mm	50	53,62	53,62	57,91	66,59
256 mm	50	60,87	60,87	65,74	75,60
288 mm	50	67,69	67,69	73,11	84,07
320 mm	50	75,09	75,09	81,10	93,26

ALM

68





### 50 Boğaziçi

1099

Siyah ●

Krom ●

İnox ●

Altın ●

Rose ●

Füme ●



#### Boğaziçi

Code : 1099  
10 x 12

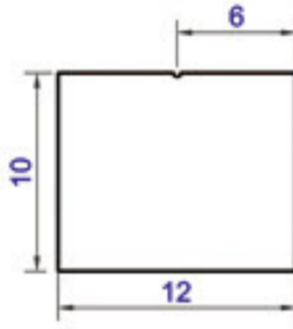

ÖLÇÜ	İkon	Siyah	Krom	İnox	Altın
128 mm	50	39,24	39,24	42,38	48,74
160 mm	50	45,74	45,74	49,40	56,81
192 mm	50	52,53	52,53	56,73	65,24
224 mm	50	60,17	60,17	64,99	74,73
256 mm	50	69,10	69,10	74,63	81,83
288 mm	50	77,61	77,61	83,81	96,39
320 mm	50	86,11	86,11	93,00	106,95

#### Eko Boğaziçi

Code : 1102 - 1  
7 x 12



ÖLÇÜ	İkon	Siyah	Krom	İnox	Altın
128 mm	50	31,28	31,28	33,78	38,85
160 mm	50	36,13	36,13	39,02	44,88
192 mm	50	40,98	40,98	44,26	50,90
224 mm	50	46,66	46,66	50,39	57,95
256 mm	50	53,01	53,01	57,25	65,84
288 mm	50	58,96	58,96	63,67	73,22
320 mm	50	65,45	65,45	70,68	81,28

#### Atlas

Code : 1102  
10 x 10

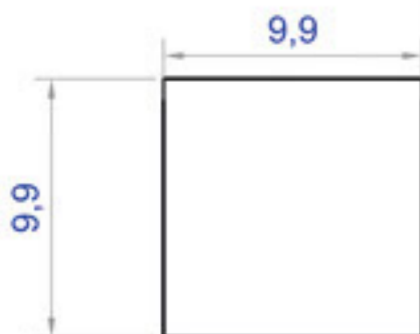

ÖLÇÜ	İkon	Siyah	Krom	İnox	Altın
128 mm	50	35,72	35,72	38,58	44,37
160 mm	50	41,40	41,40	44,72	51,42
192 mm	50	47,08	47,08	50,85	58,48
224 mm	50	53,62	53,62	57,91	66,59
256 mm	50	60,87	60,87	65,74	75,60
288 mm	50	67,69	67,69	73,11	84,07
320 mm	50	75,09	75,09	81,10	93,26



# ALUMİNYUM

## Aluminium



Ay 50

1100

- Siyah
- Krom
- İnox
- Altın
- Rose
- Füme

Ay	ÖLÇÜ		Siyah	Krom	İnox	Altın
Code : 1100 10 x 12	128 mm	50	39,24	39,24	42,38	48,74
	160 mm	50	45,74	45,74	49,40	56,81
	192 mm	50	52,53	52,53	56,73	65,24
	224 mm	50	60,17	60,17	64,99	74,73
	256 mm	50	69,10	69,10	74,63	81,83
	288 mm	50	77,61	77,61	83,81	96,39
	320 mm	50	86,11	86,11	93,00	106,95

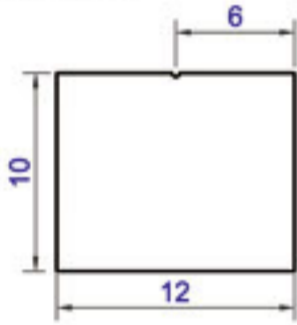

Eko Ay	ÖLÇÜ		Siyah	Krom	İnox	Altın
Code : 1104 - 1 7 x 12	128 mm	50	31,28	31,28	33,78	38,85
	160 mm	50	36,13	36,13	39,02	44,88
	192 mm	50	40,98	40,98	44,26	50,90
	224 mm	50	46,66	46,66	50,39	57,95
	256 mm	50	53,01	53,01	57,25	65,84
	288 mm	50	58,96	58,96	63,67	73,22
	320 mm	50	65,45	65,45	70,68	81,28

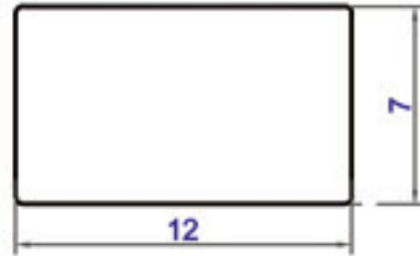

Venüs	ÖLÇÜ		Siyah	Krom	İnox	Altın
Code : 1104 10 x 10	128 mm	50	35,72	35,72	38,58	44,37
	160 mm	50	41,40	41,40	44,72	51,42
	192 mm	50	47,08	47,08	50,85	58,48
	224 mm	50	53,62	53,62	57,91	66,59
	256 mm	50	60,87	60,87	65,74	75,60
	288 mm	50	67,69	67,69	73,11	84,07
	320 mm	50	75,09	75,09	81,10	93,26

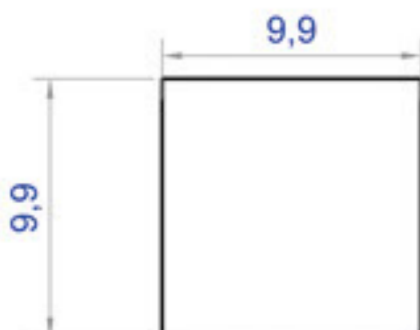

ALM

70







50

**Eko Boğaziçi  
Safran**

1105

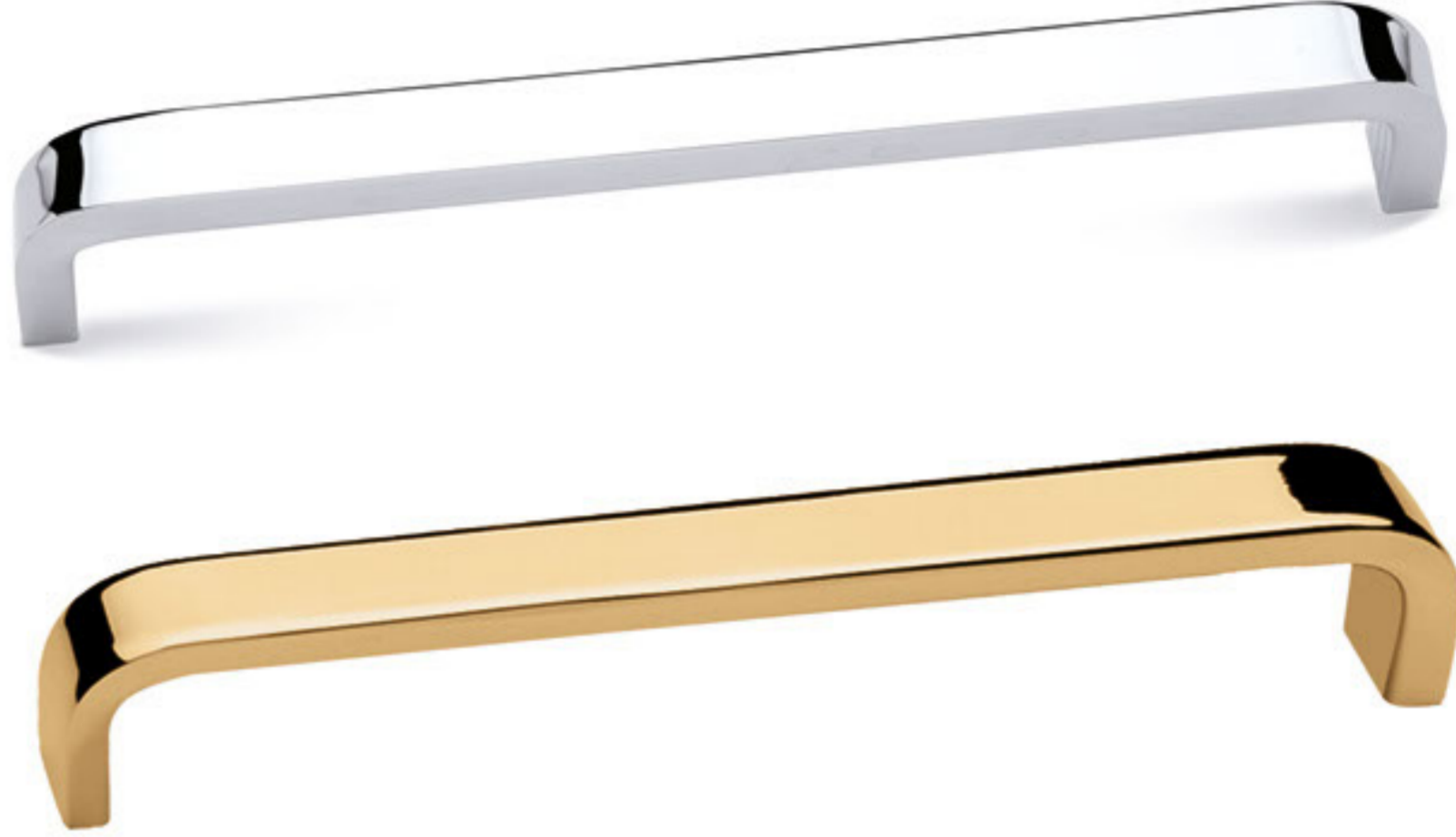
- Siyah ●
- Krom ●
- Inox ●
- Altın ●
- Rose ●
- Füme ●



Eko Boğaziçi Safran	ÖLÇÜ		Siyah	Krom	Inox	Altın
	Code : 1105 7 x 12		128 mm	50	32,45	32,45
	160 mm	50	37,30	37,30	40,28	46,33
	192 mm	50	42,15	42,15	45,52	52,35
	224 mm	50	47,82	47,82	51,65	59,40
	256 mm	50	54,18	54,18	58,51	67,29
	288 mm	50	60,12	60,12	64,93	74,67
	320 mm	50	66,61	66,61	71,95	82,73

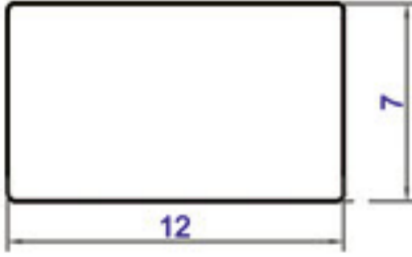

Eko Boğaziçi Safran	ÖLÇÜ		Siyah	Krom	Inox	Altın
	Code : 1105 - 1 10 x 10		128 mm	50	37,53	37,53
	160 mm	50	43,20	43,20	46,66	53,66
	192 mm	50	48,88	48,88	52,79	60,71
	224 mm	50	55,42	55,42	59,85	68,83
	256 mm	50	62,67	62,67	67,69	77,84
	288 mm	50	69,49	69,49	75,05	86,31
	320 mm	50	76,80	76,80	83,04	95,50

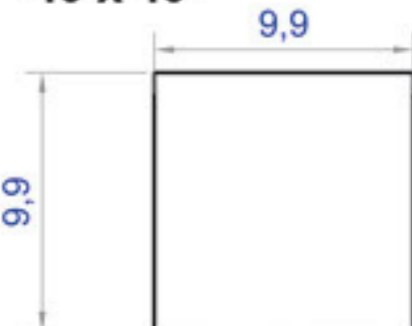
**ALM**

71





Omega 50

1101

- Siyah
- Krom
- İnox
- Altın
- Rose
- Füme



Omega	ÖLÇÜ		Siyah	Krom	İnox	Altın
Code : 1101 10 x 12	128 mm	50	44,59	44,59	48,16	55,39
	160 mm	50	51,98	51,98	56,14	64,56
	192 mm	50	59,69	59,69	64,47	74,14
	224 mm	50	68,38	68,38	73,85	84,93
	256 mm	50	78,53	78,53	84,81	97,53
	288 mm	50	88,19	88,19	95,24	109,53
	320 mm	50	97,85	97,85	105,68	121,53

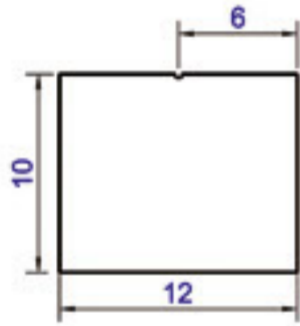

Eko Omega	ÖLÇÜ		Siyah	Krom	İnox	Altın
Code : 1106 - 1 7 x 12	128 mm	50	34,81	34,81	37,60	43,24
	160 mm	50	40,23	40,23	43,45	49,96
	192 mm	50	45,97	45,97	49,65	57,10
	224 mm	50	52,69	52,69	56,91	65,44
	256 mm	50	60,87	60,87	65,74	75,60
	288 mm	50	68,56	68,56	74,05	85,16
	320 mm	50	76,26	76,26	82,36	94,71

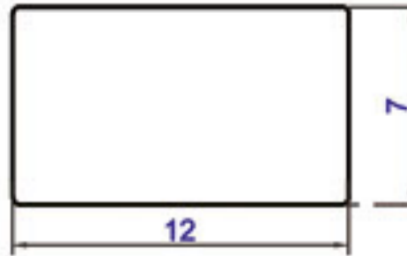

Drama	ÖLÇÜ		Siyah	Krom	İnox	Altın
Code : 1106 10 x 10	128 mm	50	37,45	37,45	40,44	46,51
	160 mm	50	43,40	43,40	46,87	53,90
	192 mm	50	49,67	49,67	53,64	61,69
	224 mm	50	56,92	56,92	61,47	70,69
	256 mm	50	65,63	65,63	70,88	81,51
	288 mm	50	73,85	73,85	79,76	91,72
	320 mm	50	82,07	82,07	88,64	101,94

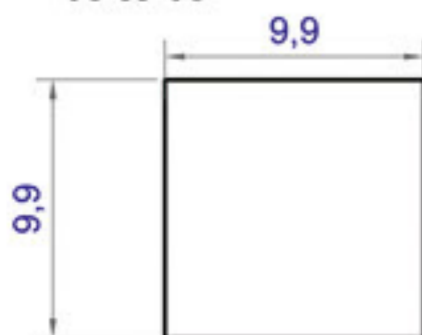



**50 Lama**

- Siyah ● 1113
- Krom ● 1114
- İnox ●
- Altın ●
- Rose ●
- Füme ●



**Düz Lama**

Code : 1113

**Çizgili Lama**

Code : 1114

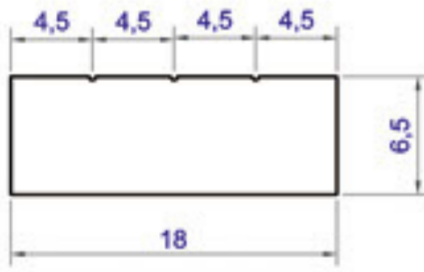
6,5 x 18



ÖLÇÜ	Box	Siyah	Krom	İnox	Altın
128 mm	50	37,28	37,28	40,26	46,30
160 mm	50	43,17	43,17	46,63	53,62
192 mm	50	49,35	49,35	53,30	61,30
224 mm	50	56,68	56,68	61,21	70,39
256 mm	50	64,72	64,72	69,89	80,38
288 mm	50	72,90	72,90	78,73	90,54
320 mm	50	80,79	80,79	87,26	100,35

**Eko Düz Lama**

Code : 1113 - 1

**Eko Çizgili Lama**

Code : 1113 - 1

6 x 16



ÖLÇÜ	Box	Siyah	Krom	İnox	Altın
128 mm	50	33,66	37,45	36,35	41,80
160 mm	50	38,93	43,40	42,04	48,35
192 mm	50	44,47	49,67	48,03	55,23
224 mm	50	51,11	56,92	55,19	63,47
256 mm	50	58,42	65,63	63,10	72,56
288 mm	50	65,88	73,85	71,15	81,82
320 mm	50	73,06	82,07	78,90	90,74





Akasya 50

1111

1112

● Siyah

● Krom

● İnox

● Altın

● Rose

● Füme

## Akasya Düz

Code : 1111

## Akasya Çizgili

Code : 1112

6,5 x 18

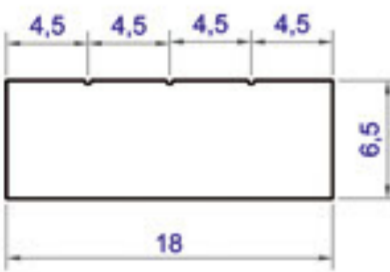

Akasya Düz	ÖLÇÜ	İkon	Siyah	Krom	İnox	Altın
Code : 1111	128 mm	50	35,76	35,76	38,62	44,42
	160 mm	50	41,66	41,66	44,99	51,74
Code : 1112	192 mm	50	47,84	47,84	51,66	59,41
	224 mm	50	55,16	55,16	59,57	68,51
	256 mm	50	63,20	63,20	68,26	78,49
	288 mm	50	71,38	71,38	77,09	88,66
	320 mm	50	79,28	79,28	85,62	98,46

## Eko Akasya Düz

Code : 1111 - 1

## Eko Akasya Çiz.

Code : 1112 - 1

6 x 16



Eko Akasya Düz	ÖLÇÜ	İkon	Siyah	Krom	İnox	Altın
Code : 1111 - 1	128 mm	50	32,39	32,39	34,98	40,23
	160 mm	50	37,66	37,66	40,67	46,77
Code : 1112 - 1	192 mm	50	43,20	43,20	46,66	53,66
	224 mm	50	49,84	49,84	53,82	61,90
	256 mm	50	57,15	57,15	61,72	70,98
	288 mm	50	64,61	64,61	69,77	80,24
	320 mm	50	71,79	71,79	77,53	89,16





**50 Göze**

- Siyah ● 1109
- Krom ● 1110
- Inox ●
- Altın ●
- Rose ●
- Füme ●

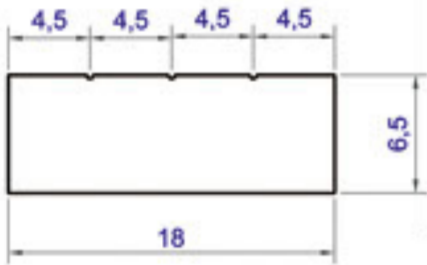

Göze Düz	ÖLÇÜ		Siyah	Krom	Inox	Altın
Code : 1109	128 mm	50	35,76	35,76	38,62	44,42
	160 mm	50	41,66	41,66	44,99	51,74
	192 mm	50	47,84	47,84	51,66	59,41
Göze Çizgili	224 mm	50	55,16	55,16	59,57	68,51
	256 mm	50	63,20	63,20	68,26	78,49
	288 mm	50	71,38	71,38	77,09	88,66
	320 mm	50	79,28	79,28	85,62	98,46



Eko Göze Düz	ÖLÇÜ		Siyah	Krom	Inox	Altın
Code : 1109 - 1	128 mm	50	32,39	32,39	34,98	40,23
	160 mm	50	37,66	37,66	40,67	46,77
	192 mm	50	43,20	43,20	46,66	53,66
Eko Göze Çizgili	224 mm	50	49,84	49,84	53,82	61,90
	256 mm	50	57,15	57,15	61,72	70,98
	288 mm	50	64,61	64,61	69,77	80,24
	320 mm	50	71,79	71,79	77,53	89,16

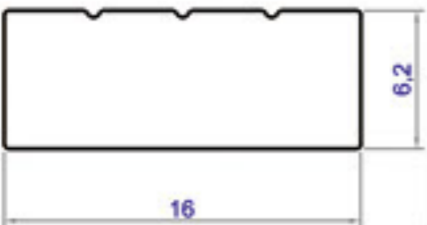





Yalı 50



1112

● Siyah

1113

● Krom

● İnox

● Altın

● Rose

● Füme

## Yalı Düz

Code : 1111

## Yalı Çizgili

Code : 1112

6,5 x 18

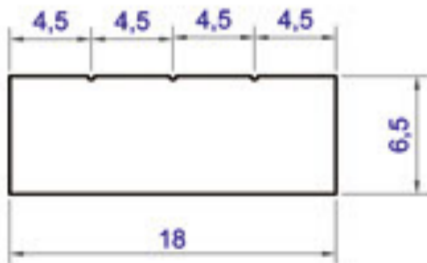

Yalı Düz	ÖLÇÜ		Siyah	Krom	İnox	Altın
Code : 1111	128 mm	50	35,76	35,76	38,62	44,42
	160 mm	50	41,66	41,66	44,99	51,74
	192 mm	50	47,84	47,84	51,66	59,41
Code : 1112	224 mm	50	55,16	55,16	59,57	68,51
	256 mm	50	63,20	63,20	68,26	78,49
	288 mm	50	71,38	71,38	77,09	88,66
	320 mm	50	79,28	79,28	85,62	98,46

## Eko Yalı Düz

Code : 1111 - 1

## Eko Yalı Çizgili

Code : 1112 - 1

6 x 16

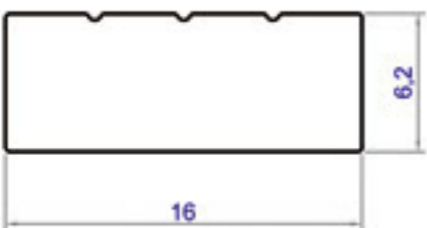

Eko Yalı Düz	ÖLÇÜ		Siyah	Krom	İnox	Altın
Code : 1111 - 1	128 mm	50	32,39	32,39	34,98	40,23
	160 mm	50	37,66	37,66	40,67	46,77
	192 mm	50	43,20	43,20	46,66	53,66
Code : 1112 - 1	224 mm	50	49,84	49,84	53,82	61,90
	256 mm	50	57,15	57,15	61,72	70,98
	288 mm	50	64,61	64,61	69,77	80,24
	320 mm	50	71,79	71,79	77,53	89,16





**50 Seyhan**
**1115**

- Siyah ●
- Krom ●
- İnox ●
- Altın ●
- Rose ●
- Füme ●

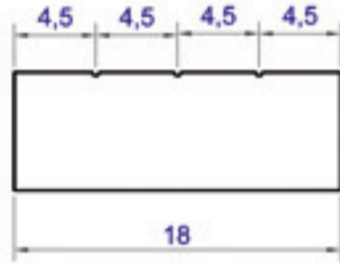

Seyhan	ÖLÇÜ		Siyah	Krom	İnox	Altın
Code : 1115	128 mm	50	40,86	40,86	44,12	50,74
6,5 x 18	160 mm	50	47,55	47,55	51,36	59,06
	192 mm	50	54,58	54,58	58,94	67,78
	224 mm	50	62,90	62,90	67,93	78,12
	256 mm	50	72,03	72,03	77,80	89,47
	288 mm	50	81,33	81,33	87,84	101,01
	320 mm	50	90,30	90,30	97,53	112,16

**50 Simav**
**1116**

- Siyah ●
- Krom ●
- İnox ●
- Altın ●
- Rose ●
- Füme ●



Simav	ÖLÇÜ		Siyah	Krom	İnox	Altın
Code : 1116	128 mm	50	40,86	40,86	44,12	50,74
6,5 x 18	160 mm	50	47,55	47,55	51,36	59,06
	192 mm	50	54,58	54,58	58,94	67,78
	224 mm	50	62,90	62,90	67,93	78,12
	256 mm	50	72,03	72,03	77,80	89,47
	288 mm	50	81,33	81,33	87,84	101,01
	320 mm	50	90,30	90,30	97,53	112,16

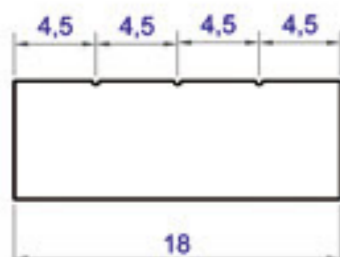



# ALUMİNYUM

## Aluminium



**Asya** 50

1118

- Siyah
- Krom
- İnox
- Altın
- Rose
- Füme



**Asya**

Code : 1118

7 x 25



ÖLÇÜ		Siyah	Krom	İnox	Altın
128 mm	50	47,98	47,98	51,82	59,19
160 mm	50	56,05	56,05	60,54	69,62
192 mm	50	64,72	64,72	69,90	80,38
224 mm	50	73,39	73,39	79,26	91,15
256 mm	50	83,40	83,40	90,08	103,59
288 mm	50	92,37	92,37	99,76	114,73
320 mm	50	101,64	101,64	109,77	126,24

**Asya Kemer**

1119



50

- Siyah
- Krom
- İnox
- Altın
- Rose
- Füme



**Asya Kemer**

Code : 1119

7 x 25



ÖLÇÜ		Siyah	Krom	İnox	Altın
128 mm	50	47,98	47,98	51,82	59,19
160 mm	50	56,05	56,05	60,54	69,62
192 mm	50	64,72	64,72	69,90	80,38
224 mm	50	73,39	73,39	79,26	91,15
256 mm	50	83,40	83,40	90,08	103,59
288 mm	50	92,37	92,37	99,76	114,73
320 mm	50	101,64	101,64	109,77	126,24

ALM

78



**50 Kozan**

- Siyah ●
- Krom ●
- İnox ●
- Altın ●
- Rose ●
- Füme ●

**1121**

Kozan	ÖLÇÜ		Siyah	Krom	İnox	Altın
Code : 1121 7 x 25	128 mm	50	47,98	47,98	51,82	59,19
	160 mm	50	56,05	56,05	60,54	69,62
	192 mm	50	64,72	64,72	69,90	80,38
	224 mm	50	73,39	73,39	79,26	91,15
	256 mm	50	83,40	83,40	90,08	103,59
	288 mm	50	92,37	92,37	99,76	114,73
	320 mm	50	101,64	101,64	109,77	126,24

**50 Soma**

- Siyah ●
- Krom ●
- İnox ●
- Altın ●
- Rose ●
- Füme ●

**1122**

Soma	ÖLÇÜ		Siyah	Krom	İnox	Altın
Code : 1122 7 x 25	128 mm	50	52,15	52,15	56,32	64,77
	160 mm	50	60,93	60,93	65,80	75,67
	192 mm	50	70,31	70,31	75,98	87,37
	224 mm	50	79,77	79,77	86,15	99,08
	256 mm	50	90,66	90,66	97,91	112,60
	288 mm	50	100,40	100,40	108,44	124,70
	320 mm	50	110,48	110,48	119,32	137,21

**ALM**
**79**



# ALUMİNYUM

Aluminium



Asya  
Safran



50

1120

- Siyah
- Krom
- İnox
- Altın
- Rose
- Füme

Asya Safran	ÖLÇÜ		Siyah	Krom	İnox	Altın
Code : 1120	128 mm	50	50,07	50,07	54,08	62,19
7 x 25	160 mm	50	58,14	58,14	62,79	72,21
	192 mm	50	66,81	66,81	72,16	82,98
	224 mm	50	75,48	75,48	81,52	93,75
	256 mm	50	85,50	85,50	92,34	106,19
	288 mm	50	94,46	94,46	102,02	117,32
	320 mm	50	103,73	103,73	112,03	128,83



Şeritli  
Olimpa



50

1124

- Siyah
- Krom
- İnox
- Altın
- Rose
- Füme

Şeritli Olimpa	ÖLÇÜ		Krom	İnox
Code : 1124	128 mm	50	63,76	
7 x 25	160 mm	50	75,27	
	192 mm	50	87,17	
	224 mm	50	99,28	
	256 mm	50	113,20	
	288 mm	50	125,31	
	320 mm	50	138,22	



ALM

80





50

### Şeritli Kozan

1123

- Siyah ●
- Krom ●
- İnox ●
- Altın ●
- Rose ●
- Füme ●



#### Şeritli Kozan

Code : 1123

7 x 25

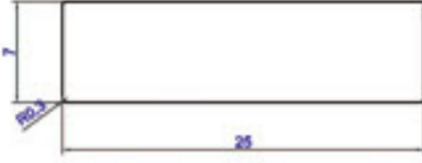

ÖLÇÜ	İkon	Krom İnox
128 mm	50	63,76
160 mm	50	75,27
192 mm	50	87,17
224 mm	50	99,28
256 mm	50	113,20
288 mm	50	125,31
320 mm	50	138,22



50

### Vizyon

1125

- Siyah ●
- Krom ●
- İnox ●
- Altın ●
- Rose ●
- Füme ●



#### Vizyon

Code : 1125

8 x 20

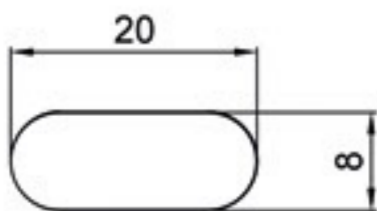

ÖLÇÜ	İkon	Siyah	Krom	İnox	Altın
128 mm	50	43,37	47,98	46,84	53,87
160 mm	50	50,56	56,05	54,61	62,80
192 mm	50	58,36	64,72	63,02	72,48
224 mm	50	66,15	73,39	71,44	82,15
256 mm	50	75,28	83,40	81,30	93,50
288 mm	50	83,37	92,37	90,04	103,55
320 mm	50	91,76	101,64	99,10	113,97

ALM

81





Miray 50

1127

- Siyah
- Krom
- İnox
- Altın
- Rose
- Füme

Miray	ÖLÇÜ	📦	Siyah	Krom	İnox	Altın
Code : 1127 8 x 20	128 mm	50	43,37	47,98	46,84	53,87
	160 mm	50	50,56	56,05	54,61	62,80
	192 mm	50	58,36	64,72	63,02	72,48
	224 mm	50	66,15	73,39	71,44	82,15
	256 mm	50	75,28	83,40	81,30	93,50
	288 mm	50	83,37	92,37	90,04	103,55
	320 mm	50	91,76	101,64	99,10	113,97

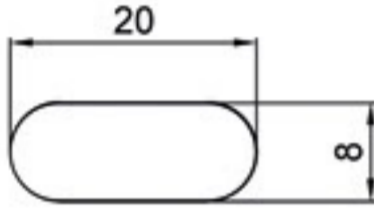

Trend 50

1128

- Siyah
- Krom
- İnox
- Altın
- Rose
- Füme

Trend	ÖLÇÜ	📦	Siyah	Krom	İnox	Altın
Code : 1128 8 x 20	128 mm	50	43,37	47,98	46,84	53,87
	160 mm	50	50,56	56,05	54,61	62,80
	192 mm	50	58,36	64,72	63,02	72,48
	224 mm	50	66,15	73,39	71,44	82,15
	256 mm	50	75,28	83,40	81,30	93,50
	288 mm	50	83,37	92,37	90,04	103,55
	320 mm	50	91,76	101,64	99,10	113,97

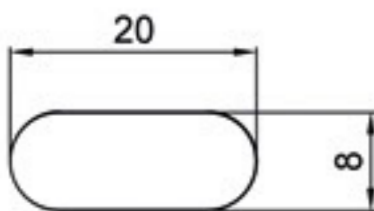

ALM

82



**50 Alfa**

- Siyah ●
- Krom ●
- İnox ●
- Altın ●
- Rose ●
- Füme ●

**1126**

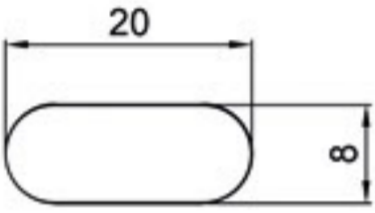
Alfa	ÖLÇÜ		Siyah	Krom	İnox	Altın
Code : 1126 8 x 20 	128 mm	50	45,32	53,90	48,95	56,29
	160 mm	50	52,52	63,02	56,72	65,23
	192 mm	50	60,31	72,82	65,13	74,90
	224 mm	50	68,10	82,62	73,55	84,58
	256 mm	50	77,23	93,94	83,41	95,92
	288 mm	50	85,32	104,08	92,15	105,97
	320 mm	50	93,71	114,56	101,21	116,39

**50 Dar L**

- Siyah ●
- Krom ●
- İnox ●
- Altın ●
- Rose ●
- Füme ●

**1129**

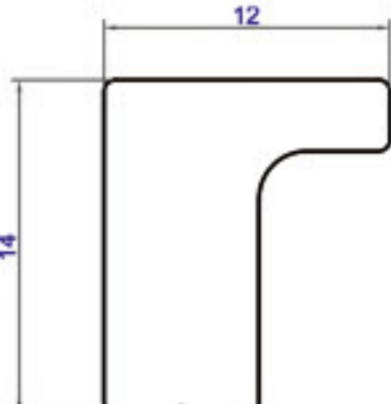
Dar L	ÖLÇÜ		Siyah	Krom	İnox	Altın
Code : 1129 12 x 14 	96 mm	50	26,93	26,93	29,09	33,45
	128 mm	50	31,79	31,79	34,33	39,48
	160 mm	50	37,19	37,19	40,17	46,20
	192 mm	50	42,87	42,87	46,30	53,25
	224 mm	50	49,64	49,64	53,61	61,65
	256 mm	50	57,09	57,09	61,66	70,96
	288 mm	50	64,68	64,68	69,85	80,33
	320 mm	50	71,99	71,99	77,75	89,41
	352 mm	50	79,17	79,17	85,50	98,33
	384 mm	50	86,48	86,48	93,40	107,41
	416 mm	50	93,52	93,52	101,01	116,16
	448 mm	50	103,30	103,30	111,56	128,29
	480 mm	50	113,07	113,07	122,11	140,43
	512 mm	50	123,11	123,11	132,96	152,90





Geniş L 50

1130



- Siyah
- Krom
- İnox
- Altın
- Rose
- Füme

Geniş L

ÖLÇÜ



Siyah

Krom

İnox

Altın

Code : 1130

7 x 23

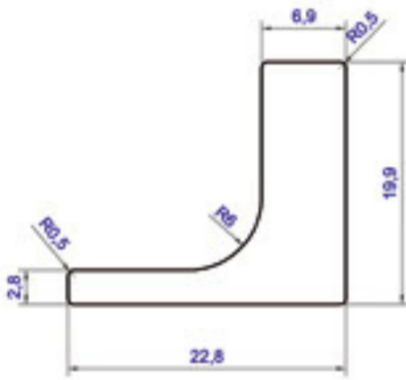

ÖLÇÜ	İbox	Siyah	Krom	İnox	Altın
96 mm	50	40,22	40,22	43,44	49,95
128 mm	50	48,68	48,68	52,58	60,47
160 mm	50	57,78	57,78	62,40	71,76
192 mm	50	67,49	67,49	72,89	83,82
224 mm	50	78,30	78,30	84,56	97,24
256 mm	50	90,51	90,51	97,75	112,41
288 mm	50	103,03	103,03	111,27	127,96
320 mm	50	116,49	116,49	125,81	144,68
352 mm	50	130,91	130,91	141,39	162,59
384 mm	50	147,19	147,19	158,97	182,81
416 mm	50	163,13	163,13	176,18	202,61
448 mm	50	183,58	183,58	198,27	228,01
480 mm	50	204,84	204,84	221,23	254,41
512 mm	50	229,22	229,22	247,56	284,69



Silver 50

1131



- Siyah
- Krom
- İnox
- Altın
- Rose
- Füme

Silver

ÖLÇÜ



Siyah

Krom

İnox

Altın

Code : 1131

7 x 20

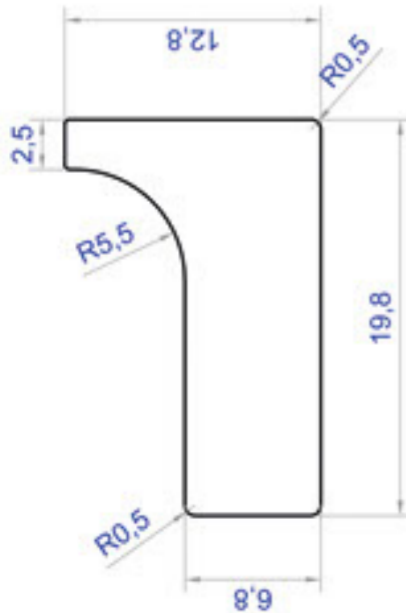

ÖLÇÜ	İbox	Siyah	Krom	İnox	Altın
96 mm	50	36,89	36,89	39,84	45,82
128 mm	50	44,39	44,39	47,94	55,13
160 mm	50	52,51	52,51	56,72	65,22
192 mm	50	61,26	61,26	66,16	76,09
224 mm	50	71,10	71,10	76,79	88,31
256 mm	50	82,34	82,34	88,93	102,27
288 mm	50	93,90	93,90	101,41	116,62
320 mm	50	106,39	106,39	114,90	132,14
352 mm	50	119,85	119,85	129,44	148,85
384 mm	50	135,04	135,04	145,84	167,72
416 mm	50	150,13	150,13	162,14	186,47
448 mm	50	169,61	169,61	183,18	210,66
480 mm	50	189,90	189,90	205,10	235,86
512 mm	50	213,32	213,32	230,38	264,94

ALM

84





### 50 T Kulp 1132

- Siyah ●
- Krom ●
- İnox ●
- Altın ●
- Rose ●
- Füme ●

**T Kulp**  
Code : 1132  
7,5 x 16

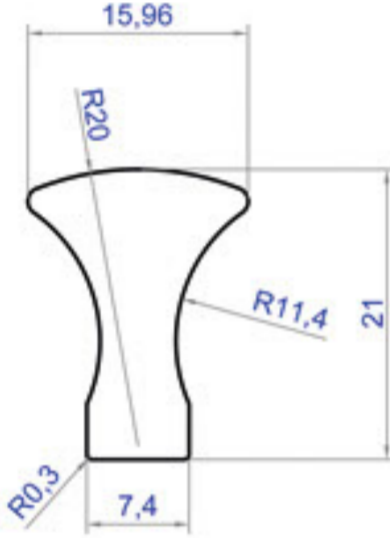

T Kulp	ÖLÇÜ	İkon	Siyah	Krom	İnox	Altın
	96 mm	50	38,82	38,82	41,92	48,21
	128 mm	50	46,88	46,88	50,63	58,22
	160 mm	50	55,56	55,56	60,01	69,01
	192 mm	50	64,87	64,87	70,06	80,57
	224 mm	50	75,27	75,27	81,29	93,48
	256 mm	50	87,07	87,07	94,04	108,14
	288 mm	50	99,18	99,18	107,12	123,19
	320 mm	50	112,24	112,24	121,21	139,40
	352 mm	50	126,25	126,25	136,35	156,81
	384 mm	50	142,08	142,08	153,44	176,46
	416 mm	50	157,66	157,66	170,27	195,81
	448 mm	50	177,70	177,70	191,92	220,70
	480 mm	50	198,55	198,55	214,44	246,60
	512 mm	50	222,52	222,52	240,32	276,37



### 50 Piramit Yay

- Siyah ●
- Krom ●
- İnox ●
- Altın ●
- Rose ●
- Füme ●

**Piramit Yay**  
Code : 1141  
8,5 x 15

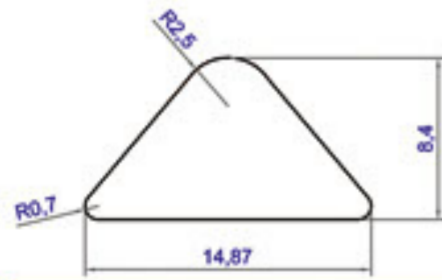

Piramit Yay	ÖLÇÜ	İkon	Siyah	Krom	İnox	Altın
	128 mm	50	31,33	31,33	33,84	38,92
	160 mm	50	36,82	36,82	39,77	45,74
	192 mm	50	42,15	42,15	45,53	52,35
	224 mm	50	49,48	49,48	53,44	61,46
	256 mm	50	55,51	55,51	59,95	68,94
	288 mm	50	62,71	62,71	67,72	77,88
	320 mm	50	71,12	71,12	76,81	88,33

**Lüks Piramit Yay**  
Code : 1141 - 1  
8,5 x 15



Lüks Piramit Yay	ÖLÇÜ	İkon	Siyah	Krom	İnox	Altın
	128 mm	50	35,22	35,22	38,04	43,74
	160 mm	50	41,09	41,09	44,38	51,04
	192 mm	50	47,16	47,16	50,94	58,58
	224 mm	50	55,24	55,24	59,66	68,60
	256 mm	50	61,59	61,59	66,52	76,50
	288 mm	50	69,49	69,49	75,05	86,31
	320 mm	50	78,54	78,54	84,82	97,55





**Piramit** 50  
1139

Piramit	ÖLÇÜ		Siyah	Krom	İnox	Altın
Code : 1139 8,5 x 15	128 mm	50	31,33	31,33	33,84	38,92
	160 mm	50	36,82	36,82	39,77	45,74
	192 mm	50	42,15	42,15	45,53	52,35
	224 mm	50	49,48	49,48	53,44	61,46
	256 mm	50	55,51	55,51	59,95	68,94
	288 mm	50	62,71	62,71	67,72	77,88
	320 mm	50	71,12	71,12	76,81	88,33

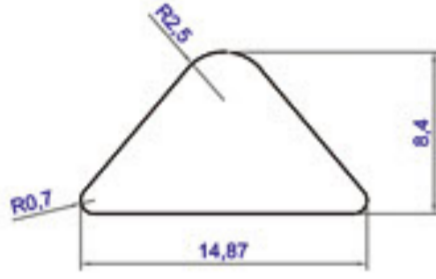

- Siyah
- Krom
- İnox
- Altın
- Rose
- Füme

Lüks Piramit	ÖLÇÜ		Siyah	Krom	İnox	Altın
Code : 1139 - 1 8,5 x 15	128 mm	50	35,22	35,22	38,04	43,74
	160 mm	50	41,09	41,09	44,38	51,04
	192 mm	50	47,16	47,16	50,94	58,58
	224 mm	50	55,24	55,24	59,66	68,60
	256 mm	50	61,59	61,59	66,52	76,50
	288 mm	50	69,49	69,49	75,05	86,31
	320 mm	50	78,54	78,54	84,82	97,55

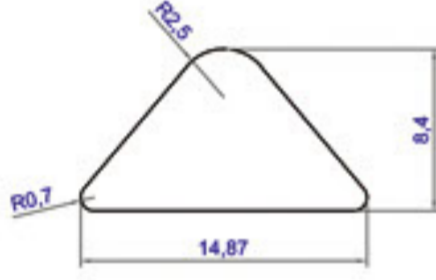

**Piramit Şahin** 50

Piramit Şahin	ÖLÇÜ		Siyah	Krom	İnox	Altın
Code : 1140 8,5 x 20	128 mm	50	31,33	31,33	33,84	38,92
	160 mm	50	36,82	36,82	39,77	45,74
	192 mm	50	42,15	42,15	45,53	52,35
	224 mm	50	49,48	49,48	53,44	61,46
	256 mm	50	55,51	55,51	59,95	68,94
	288 mm	50	62,71	62,71	67,72	77,88
	320 mm	50	71,12	71,12	76,81	88,33

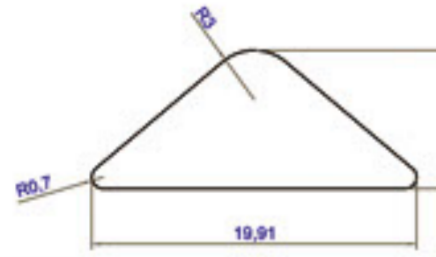

Lüks Piramit Şahin	ÖLÇÜ		Siyah	Krom	İnox	Altın
Code : 1140 - 1 8,5 x 20	128 mm	50	35,22	35,22	38,04	43,74
	160 mm	50	41,09	41,09	44,38	51,04
	192 mm	50	47,16	47,16	50,94	58,58
	224 mm	50	55,24	55,24	59,66	68,60
	256 mm	50	61,59	61,59	66,52	76,50
	288 mm	50	69,49	69,49	75,05	86,31
	320 mm	50	78,54	78,54	84,82	97,55

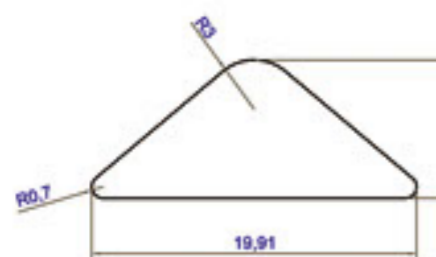

- Siyah
- Krom
- İnox
- Altın
- Rose
- Füme

ALM

86



**50**
**Efsane İnce**

Siyah ●

Krom ●

İnox ●

Altın ●

Rose ●

Füme ●

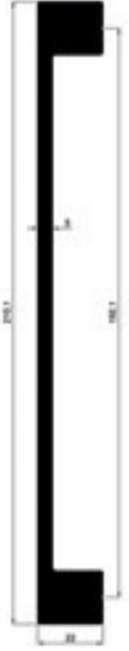
**1134**

Efsane İnce	Ölçü	Siyah	Krom	İnox	Altın
<b>10 mm</b>	96 mm	37,39	37,39	40,38	46,44
Code : 1134 5 x 22 📦 50	128 mm	42,66	42,66	46,07	52,98
	160 mm	48,20	48,20	52,06	59,87
	192 mm	54,06	54,06	58,38	67,14
	224 mm	60,50	60,50	65,34	75,14
	<b>12 mm</b>	96 mm	40,82	40,82	44,08
Code : 1134 5 x 22 📦 50	128 mm	46,39	46,39	50,10	57,62
	160 mm	52,26	52,26	56,44	64,91
	192 mm	58,44	58,44	63,11	72,58
	224 mm	65,22	65,22	70,44	81,01
	<b>15 mm</b>	96 mm	44,92	44,92	48,51
Code : 1134 5 x 22 📦 50	128 mm	50,90	50,90	54,97	63,22
	160 mm	57,20	57,20	61,77	71,04
	192 mm	63,81	63,81	68,92	79,25
	224 mm	71,05	71,05	76,73	88,24

**ALM**
**87**



Efsane  
Geniş

50

1135

- Siyah
- Krom
- İnox
- Altın
- Rose
- Füme

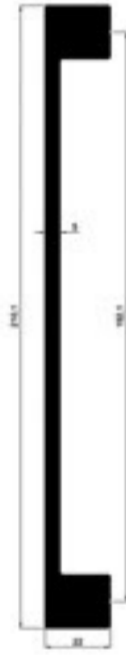

Efsane İnce	Ölçü	Siyah	Krom	İnox	Altın
<b>18 mm</b>					
Code : 1135 5 x 22 50	128 mm	59,75	59,75	64,53	74,21
	160 mm	66,98	66,98	72,34	83,19
	192 mm	75,15	75,15	81,16	93,34
	224 mm	84,44	84,44	91,19	104,87
<b>20 mm</b>					
Code : 1135 5 x 22 50	128 mm	64,91	67,62	70,10	80,62
	160 mm	73,06	76,10	78,90	90,74
	192 mm	82,14	85,56	88,71	102,02
	224 mm	88,62	92,31	95,71	110,06
<b>25 mm</b>					
Code : 1135 5 x 22 50	128 mm	76,27	79,45	82,37	94,73
	160 mm	85,49	89,05	92,33	106,17
	192 mm	95,33	99,30	102,95	118,39
	224 mm	108,83	113,37	117,54	135,17

ALM

88





50

### Yeni Gömme

1137

Siyah ●

Krom ●

Inox ●

Altın ●

Rose ●

Füme ●



**Krom  
M.Krom**

Box	96 mm	128 mm	160 mm	192 mm	224 mm	256 mm	288 mm	320 mm
50	42,21	46,27	50,34	54,40	58,46	62,52	66,59	70,65



50

### Sebat Gömme

1136

Siyah ●

Krom ●

Inox ●

Altın ●

Rose ●

Füme ●



**Krom  
M.Krom**

Box	96 mm	128 mm	160 mm	192 mm	224 mm	256 mm	288 mm	320 mm
50	32,66	35,50	38,35	41,19	44,03	46,88	49,72	52,56



50

### T Boru

1138

Siyah ●

Krom ●

Inox ●

Altın ●

Rose ●

Füme ●



**Krom  
M.Krom**

Box	96 mm	128 mm	160 mm	192 mm	224 mm	256 mm	288 mm	320 mm
50	40,50	42,50	44,00	45,50	47,50	49,00	51,00	53,00

ALM

89



# ALUMİNYUM PROFİL ÇEŞİTLERİMİZ

6063 Aluminyum Alaşımı Profilleri.

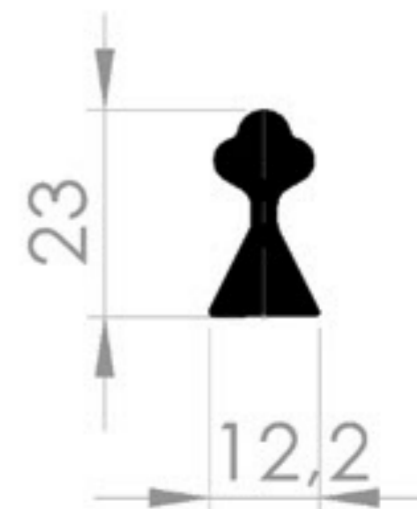
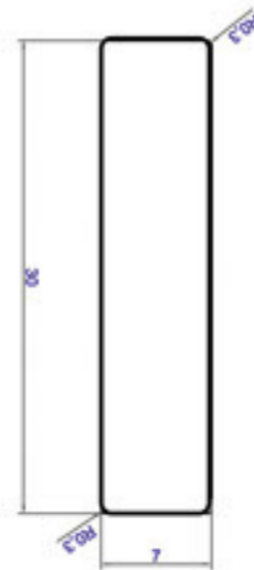
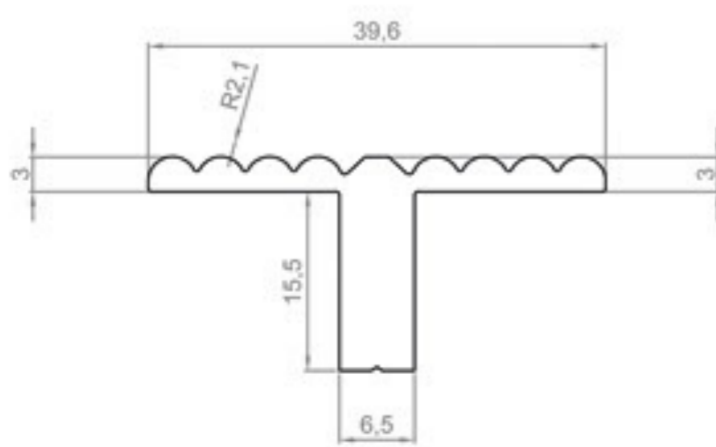
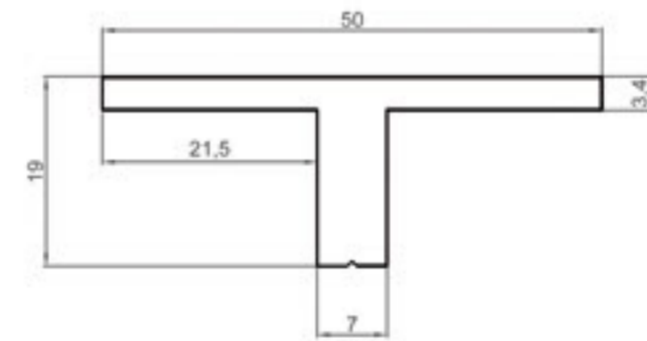
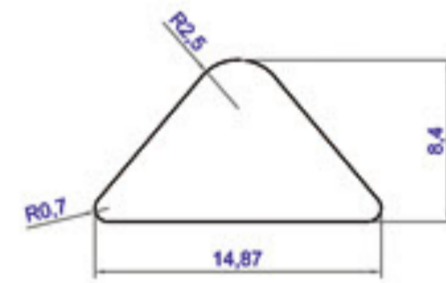
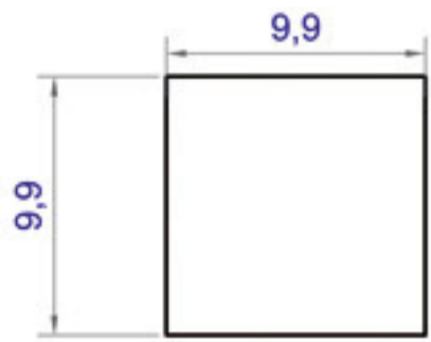
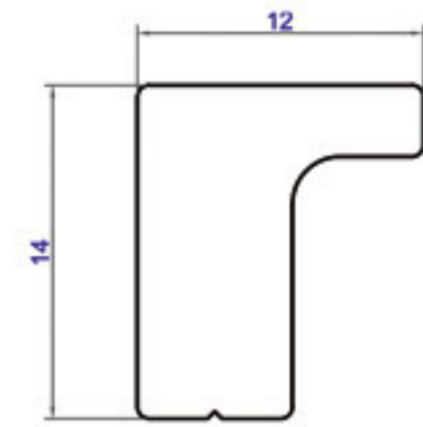
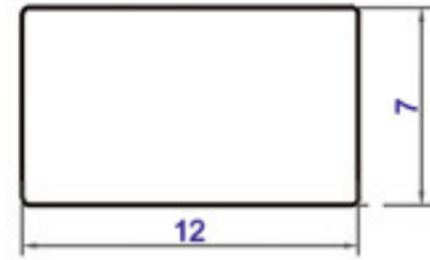
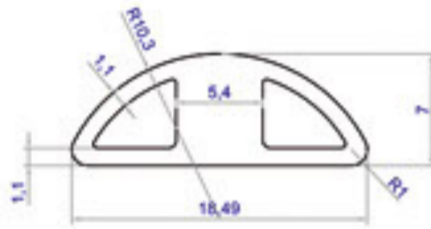
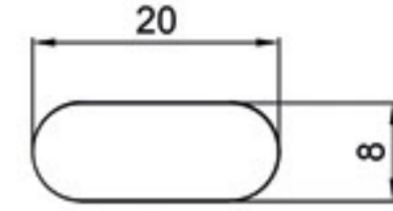
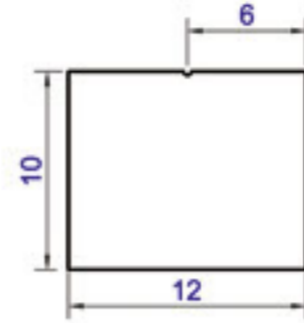
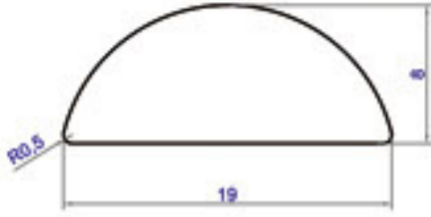
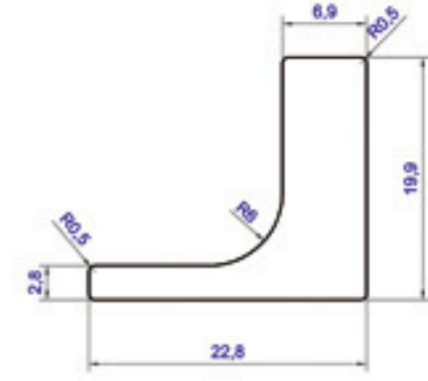
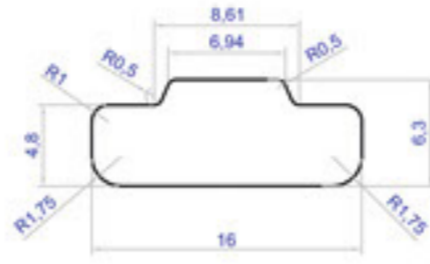
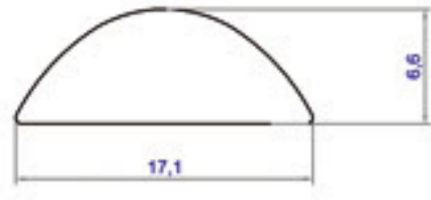

ALM

90





# *Aluminyum Cnc*

Cnc İle Üretilen Aluminyum Kulplar Yatak Odası Mobilyaınıza Şıklık Katacak...

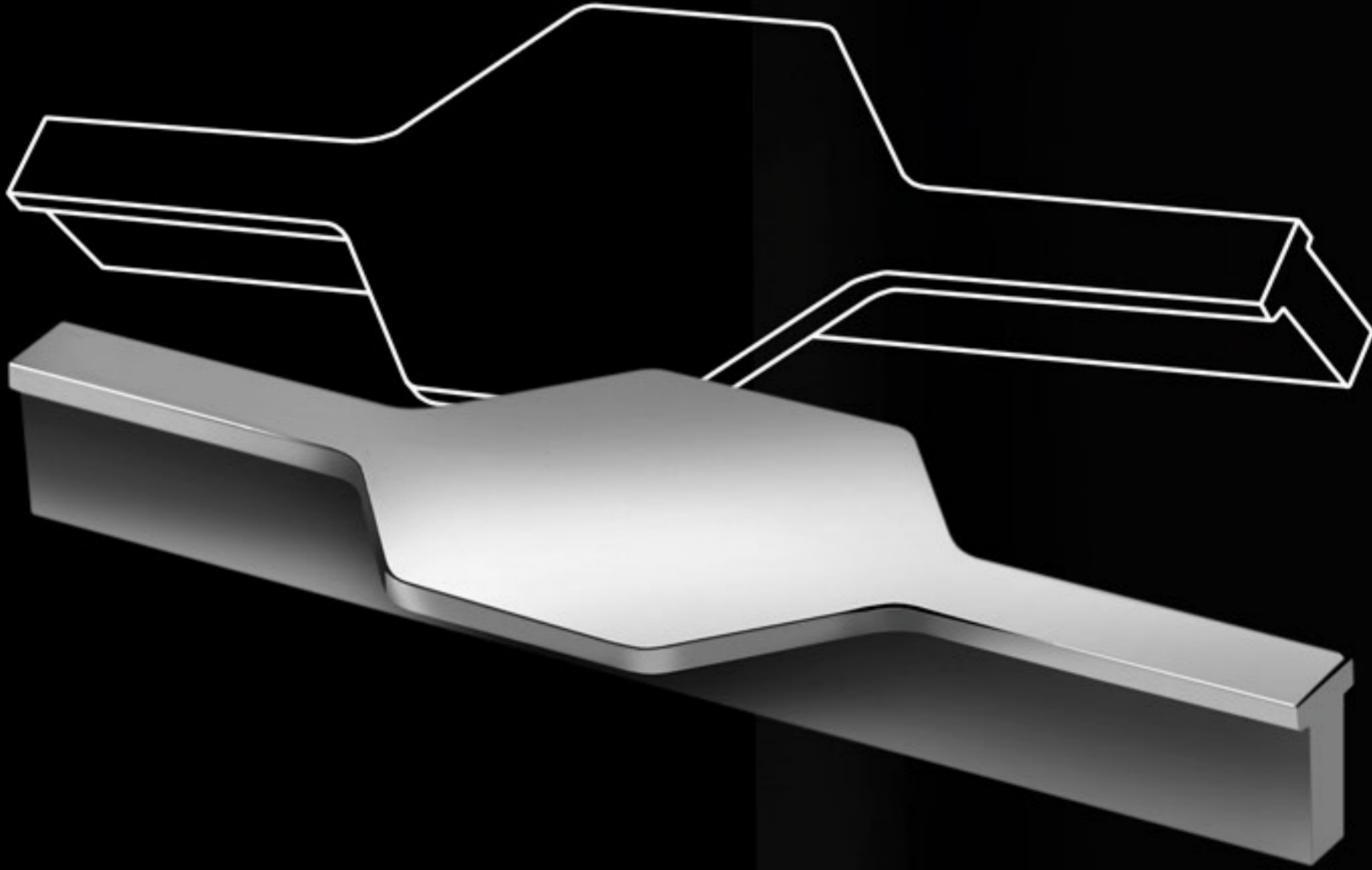

32mm / 512mm Ölçülerde Aluminyum Yatak Odası Mobilya Kulpları Siyah - Krom - İnox - Altın ve Daha Birçok Renk Seçenekleri ile Sizlerin Beğenisine Sunulmaktadır.





DEĞİŞİM furniture accesories

Safir / 112



New Model  
Safir





**50 London**
**3000**

- Siyah ●
- Krom ●
- İnox ●
- Altın ●

**London**

Code : 3000

 50

Ölçü	Siyah	Krom	İnox	Altın
128 mm	107,93	107,93	118,72	136,53
160 mm	119,15	119,15	131,06	150,72
192 mm	131,34	131,34	144,47	166,14
224 mm	146,45	146,45	161,09	185,25
256 mm	172,24	172,24	189,47	217,89
288 mm	185,89	185,89	204,48	235,15
320 mm	199,54	199,54	219,49	252,42
352 mm	235,06	235,06	258,56	297,35
416 mm	252,76	252,76	278,03	319,74
416 mm	275,31	275,31	302,85	348,27
448 mm	293,01	293,01	322,31	370,66
480 mm	313,95	313,95	345,35	397,15
512 mm	326,79	326,79	359,47	413,39



# ALUMİNYUM CNC

## Aluminium Cnc



Paris 50

3001

- Siyah
- Krom
- İnox
- Altın



Paris

Code : 3001

50

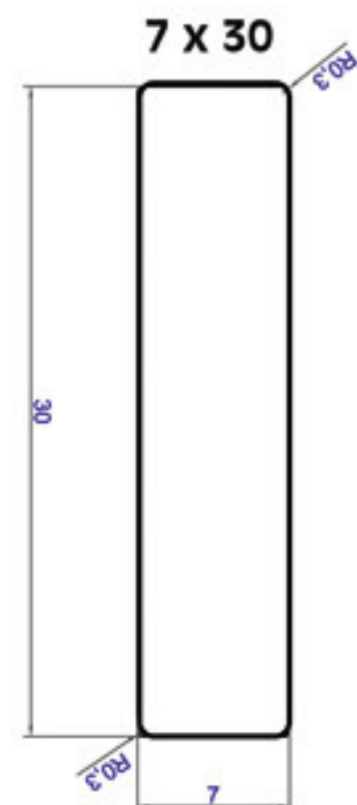

Ölçü

Siyah

Krom

İnox

Altın

128 mm

115,91

115,91

127,50

146,62

160 mm

127,13

127,13

139,84

160,82

192 mm

139,32

139,32

153,25

176,24

224 mm

154,42

154,42

169,87

195,35

256 mm

180,22

180,22

198,24

227,98

288 mm

193,87

193,87

213,26

245,25

320 mm

207,52

207,52

228,27

262,51

352 mm

243,04

243,04

267,34

307,44

416 mm

260,73

260,73

286,81

329,83

416 mm

283,29

283,29

311,62

358,37

448 mm

300,99

300,99

331,09

380,75

480 mm

321,93

321,93

354,12

407,24

512 mm

334,77

334,77

368,24

423,48

ALM  
CNC

92



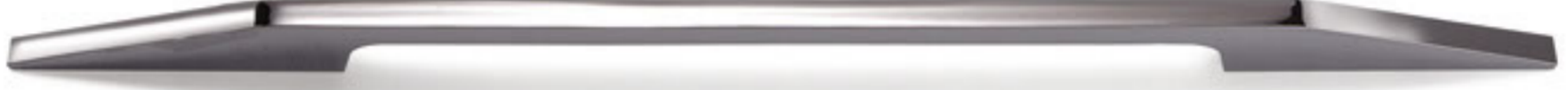

**50 Dubai**

- Siyah ●  
 Krom ●  
 İnox ●  
 Altın ●

**3002**

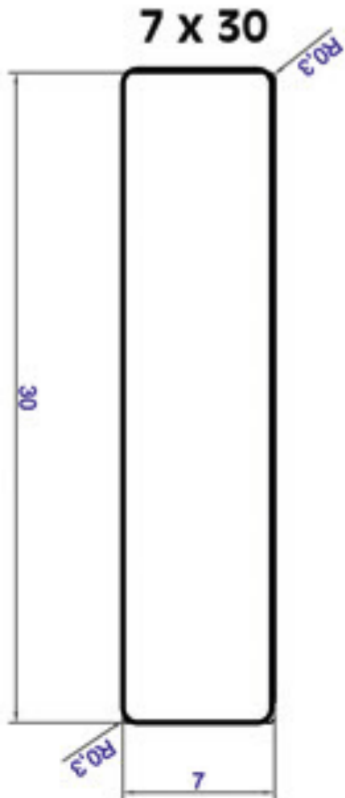
**Dubai**

Code : 3002

 50

Ölçü	Siyah	Krom	İnox	Altın
128 mm	115,91	115,91	127,50	146,62
160 mm	127,13	127,13	139,84	160,82
192 mm	139,32	139,32	153,25	176,24
224 mm	154,42	154,42	169,87	195,35
256 mm	180,22	180,22	198,24	227,98
288 mm	193,87	193,87	213,26	245,25
320 mm	207,52	207,52	228,27	262,51
352 mm	243,04	243,04	267,34	307,44
416 mm	260,73	260,73	286,81	329,83
416 mm	283,29	283,29	311,62	358,37
448 mm	300,99	300,99	331,09	380,75
480 mm	321,93	321,93	354,12	407,24
512 mm	334,77	334,77	368,24	423,48



# ALUMİNYUM CNC

## Aluminium Cnc



**Batum** 50

3003

- Siyah
- Krom
- İnox
- Altın



### Batum

Code : 3003

50

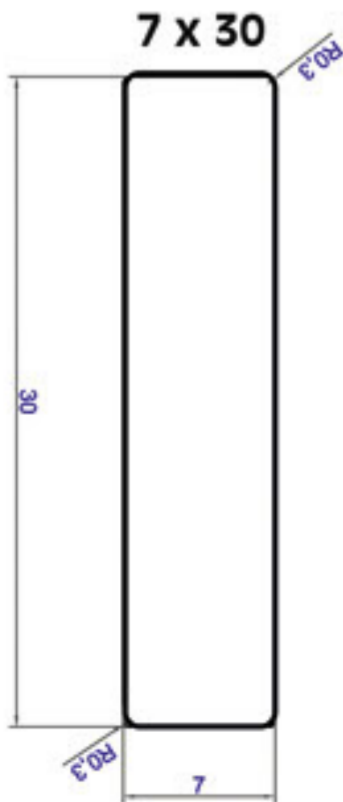

Ölçü	Siyah	Krom	İnox	Altın
128 mm	107,93	107,93	118,72	136,53
160 mm	119,15	119,15	131,06	150,72
192 mm	131,34	131,34	144,47	166,14
224 mm	146,45	146,45	161,09	185,25
256 mm	172,24	172,24	189,47	217,89
288 mm	185,89	185,89	204,48	235,15
320 mm	199,54	199,54	219,49	252,42
352 mm	235,06	235,06	258,56	297,35
416 mm	252,76	252,76	278,03	319,74
416 mm	275,31	275,31	302,85	348,27
448 mm	293,01	293,01	322,31	370,66
480 mm	313,95	313,95	345,35	397,15
512 mm	326,79	326,79	359,47	413,39

ALM  
CNC

94





**50 Venedik**
**3004**

- Siyah ●  
 Krom ●  
 İnox ●  
 Altın ●

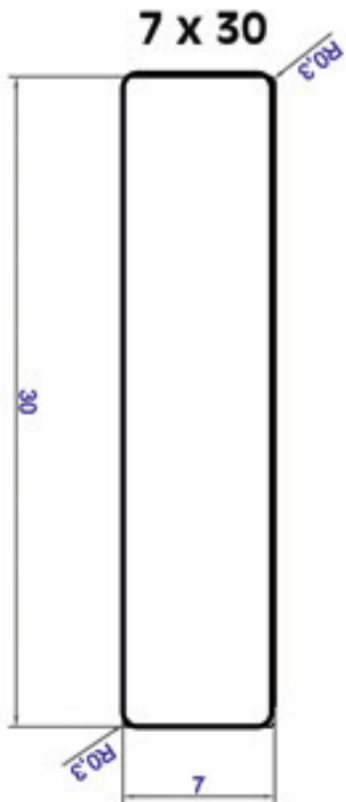

Venedik	Ölçü	Siyah	Krom	İnox	Altın
Code : 3004	128 mm	107,93	107,93	118,72	136,53
 50	160 mm	119,15	119,15	131,06	150,72
	192 mm	131,34	131,34	144,47	166,14
	224 mm	146,45	146,45	161,09	185,25
	256 mm	172,24	172,24	189,47	217,89
	288 mm	185,89	185,89	204,48	235,15
	320 mm	199,54	199,54	219,49	252,42
	352 mm	235,06	235,06	258,56	297,35
	416 mm	252,76	252,76	278,03	319,74
	416 mm	275,31	275,31	302,85	348,27
	448 mm	293,01	293,01	322,31	370,66
	480 mm	313,95	313,95	345,35	397,15
	512 mm	326,79	326,79	359,47	413,39





# ALUMİNYUM CNC

## Aluminium Cnc



**Kavs** 50

3005

- Siyah
- Krom
- İnox
- Altın



### Kavs

Code : 3005

50

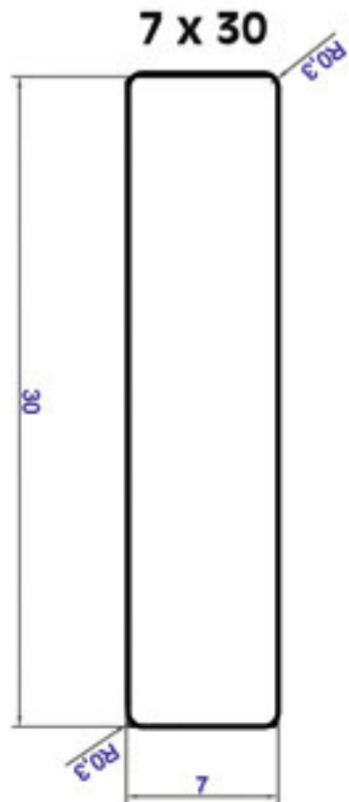

Ölçü	Siyah	Krom	İnox	Altın
128 mm	107,93	107,93	118,72	136,53
160 mm	119,15	119,15	131,06	150,72
192 mm	131,34	131,34	144,47	166,14
224 mm	146,45	146,45	161,09	185,25
256 mm	172,24	172,24	189,47	217,89
288 mm	185,89	185,89	204,48	235,15
320 mm	199,54	199,54	219,49	252,42
352 mm	235,06	235,06	258,56	297,35
416 mm	252,76	252,76	278,03	319,74
416 mm	275,31	275,31	302,85	348,27
448 mm	293,01	293,01	322,31	370,66
480 mm	313,95	313,95	345,35	397,15
512 mm	326,79	326,79	359,47	413,39

ALM  
CNC

96



**50 Moon**
**3006**

- Siyah ●
- Krom ●
- İnox ●
- Altın ●

**Moon**

Code : 3006

 50

Ölçü	Siyah	Krom	İnox	Altın
128 mm	107,93	107,93	118,72	136,53
160 mm	119,15	119,15	131,06	150,72
192 mm	131,34	131,34	144,47	166,14
224 mm	146,45	146,45	161,09	185,25
256 mm	172,24	172,24	189,47	217,89
288 mm	185,89	185,89	204,48	235,15
320 mm	199,54	199,54	219,49	252,42
352 mm	235,06	235,06	258,56	297,35
416 mm	252,76	252,76	278,03	319,74
416 mm	275,31	275,31	302,85	348,27
448 mm	293,01	293,01	322,31	370,66
480 mm	313,95	313,95	345,35	397,15
512 mm	326,79	326,79	359,47	413,39



# ALUMİNYUM CNC

## Aluminium Cnc



Luna 50

3007

- Siyah
- Krom
- İnox
- Altın



Luna

Code : 3007

50

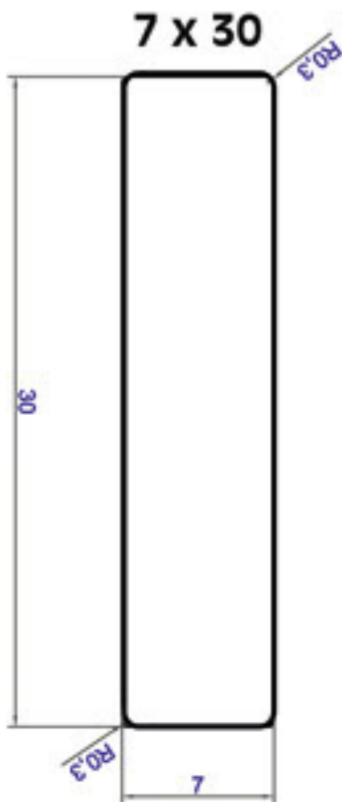

Ölçü

Siyah

Krom

İnox

Altın

128 mm

107,93

107,93

118,72

136,53

160 mm

119,15

119,15

131,06

150,72

192 mm

131,34

131,34

144,47

166,14

224 mm

146,45

146,45

161,09

185,25

256 mm

172,24

172,24

189,47

217,89

288 mm

185,89

185,89

204,48

235,15

320 mm

199,54

199,54

219,49

252,42

352 mm

235,06

235,06

258,56

297,35

416 mm

252,76

252,76

278,03

319,74

416 mm

275,31

275,31

302,85

348,27

448 mm

293,01

293,01

322,31

370,66

480 mm

313,95

313,95

345,35

397,15

512 mm

326,79

326,79

359,47

413,39

ALM  
CNC

98



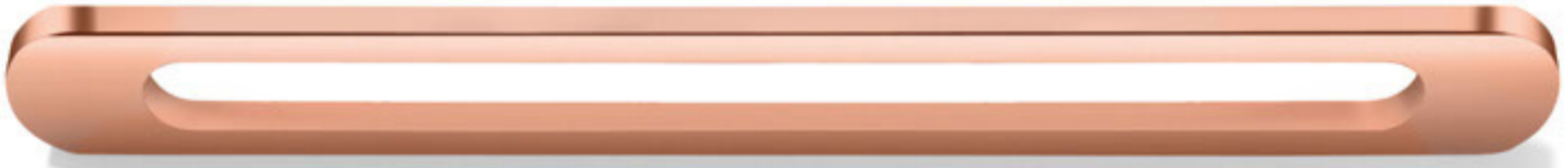

**50 Orkide**
**3008**

- Siyah ●
- Krom ●
- İnox ●
- Altın ●

**Orkide**

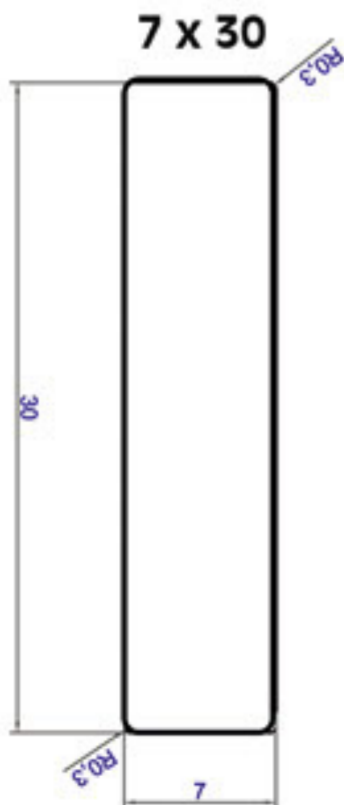
Code : 3008

 50

Ölçü	Siyah	Krom	İnox	Altın
128 mm	107,93	107,93	118,72	136,53
160 mm	119,15	119,15	131,06	150,72
192 mm	131,34	131,34	144,47	166,14
224 mm	146,45	146,45	161,09	185,25
256 mm	172,24	172,24	189,47	217,89
288 mm	185,89	185,89	204,48	235,15
320 mm	199,54	199,54	219,49	252,42
352 mm	235,06	235,06	258,56	297,35
416 mm	252,76	252,76	278,03	319,74
416 mm	275,31	275,31	302,85	348,27
448 mm	293,01	293,01	322,31	370,66
480 mm	313,95	313,95	345,35	397,15
512 mm	326,79	326,79	359,47	413,39



# ALUMİNYUM CNC

## Aluminium Cnc



Leylak 50

3009

- Siyah
- Krom
- İnox
- Altın

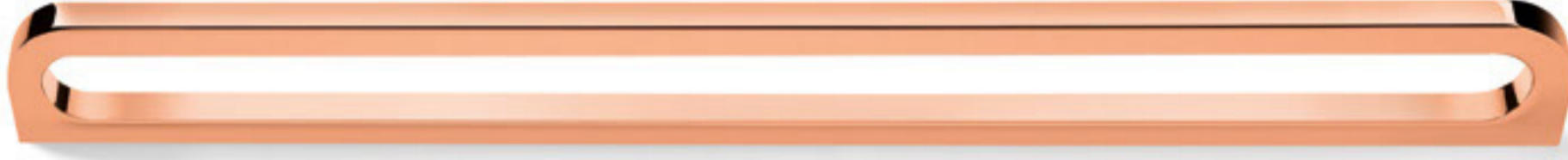

Leylak	Ölçü	Siyah	Krom	İnox	Altın
Code : 3009	128 mm	107,93	107,93	118,72	136,53
50	160 mm	119,15	119,15	131,06	150,72
	192 mm	131,34	131,34	144,47	166,14
	224 mm	146,45	146,45	161,09	185,25
	256 mm	172,24	172,24	189,47	217,89
	288 mm	185,89	185,89	204,48	235,15
	320 mm	199,54	199,54	219,49	252,42
	352 mm	235,06	235,06	258,56	297,35
	416 mm	252,76	252,76	278,03	319,74
	416 mm	275,31	275,31	302,85	348,27
	448 mm	293,01	293,01	322,31	370,66
	480 mm	313,95	313,95	345,35	397,15
	512 mm	326,79	326,79	359,47	413,39

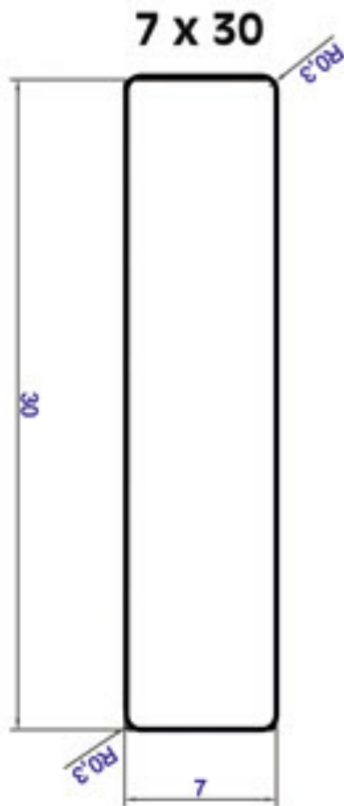

ALM  
CNC

100



**50**
**Menekşe**
**3010**

- Siyah ●
- Krom ●
- Inox ●
- Altın ●

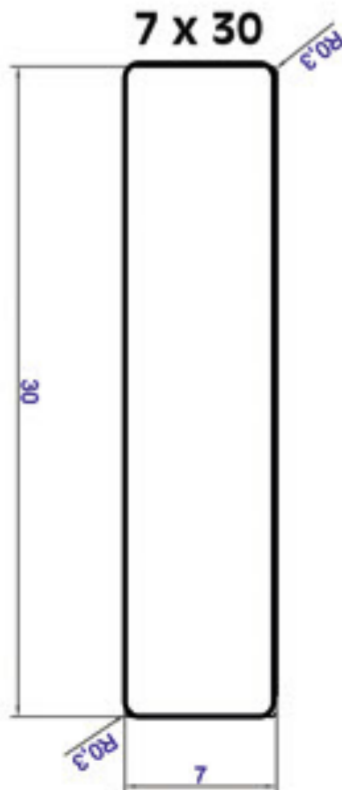
**Menekşe**
**Code : 3010**
 **50**

Ölçü	Siyah	Krom	Inox	Altın
128 mm	107,93	107,93	118,72	136,53
160 mm	119,15	119,15	131,06	150,72
192 mm	131,34	131,34	144,47	166,14
224 mm	146,45	146,45	161,09	185,25
256 mm	172,24	172,24	189,47	217,89
288 mm	185,89	185,89	204,48	235,15
320 mm	199,54	199,54	219,49	252,42
352 mm	235,06	235,06	258,56	297,35
416 mm	252,76	252,76	278,03	319,74
416 mm	275,31	275,31	302,85	348,27
448 mm	293,01	293,01	322,31	370,66
480 mm	313,95	313,95	345,35	397,15
512 mm	326,79	326,79	359,47	413,39



# ALUMİNYUM CNC

## Aluminium Cnc



Erguvan 50

3011

- Siyah
- Krom
- İnox
- Altın



Erguvan	Ölçü	Siyah	Krom	İnox	Altın
Code : 3011	128 mm	107,93	107,93	118,72	136,53
50	160 mm	119,15	119,15	131,06	150,72
	192 mm	131,34	131,34	144,47	166,14
	224 mm	146,45	146,45	161,09	185,25
	256 mm	172,24	172,24	189,47	217,89
	288 mm	185,89	185,89	204,48	235,15
	320 mm	199,54	199,54	219,49	252,42
	352 mm	235,06	235,06	258,56	297,35
	416 mm	252,76	252,76	278,03	319,74
	416 mm	275,31	275,31	302,85	348,27
	448 mm	293,01	293,01	322,31	370,66
	480 mm	313,95	313,95	345,35	397,15
	512 mm	326,79	326,79	359,47	413,39

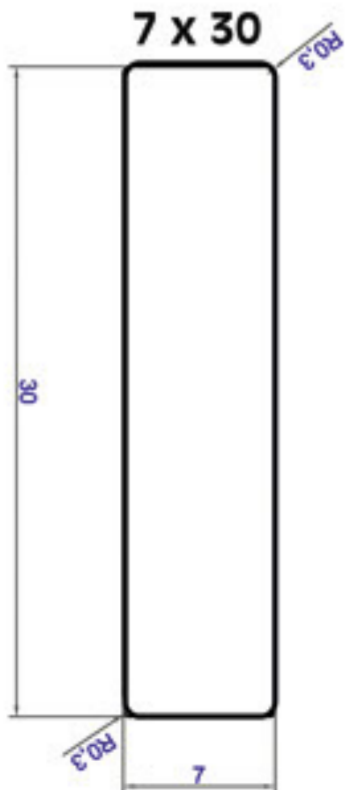

ALM  
CNC

102





**50 Oniks**
**3012**

- Siyah ●
- Krom ●
- İnox ●
- Altın ●

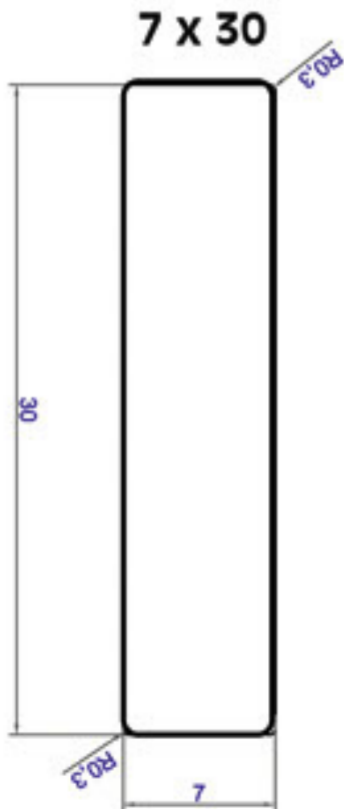

Oniks	Ölçü	Siyah	Krom	İnox	Altın
Code : 3012	128 mm	107,93	107,93	118,72	136,53
 50	160 mm	119,15	119,15	131,06	150,72
	192 mm	131,34	131,34	144,47	166,14
	224 mm	146,45	146,45	161,09	185,25
	256 mm	172,24	172,24	189,47	217,89
	288 mm	185,89	185,89	204,48	235,15
	320 mm	199,54	199,54	219,49	252,42
	352 mm	235,06	235,06	258,56	297,35
	416 mm	252,76	252,76	278,03	319,74
	416 mm	275,31	275,31	302,85	348,27
	448 mm	293,01	293,01	322,31	370,66
	480 mm	313,95	313,95	345,35	397,15
	512 mm	326,79	326,79	359,47	413,39





# ALUMİNYUM CNC

## Aluminium Cnc



**Hook** 50  
3013

- Siyah
- Krom
- İnox
- Altın



Hook	Ölçü	Siyah	Krom	İnox	Altın
Code : 3013	128 mm	107,93	107,93	118,72	136,53
50	160 mm	119,15	119,15	131,06	150,72
	192 mm	131,34	131,34	144,47	166,14
	224 mm	146,45	146,45	161,09	185,25
	256 mm	172,24	172,24	189,47	217,89
	288 mm	185,89	185,89	204,48	235,15
	320 mm	199,54	199,54	219,49	252,42
	352 mm	235,06	235,06	258,56	297,35
	416 mm	252,76	252,76	278,03	319,74
	416 mm	275,31	275,31	302,85	348,27
	448 mm	293,01	293,01	322,31	370,66
	480 mm	313,95	313,95	345,35	397,15
	512 mm	326,79	326,79	359,47	413,39

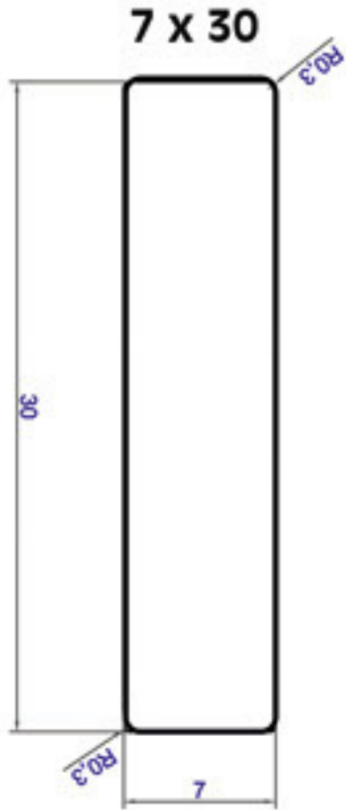

ALM  
CNC

104





**50 Aras**

- Siyah ●  
 Krom ●  
 İnox ●  
 Altın ●

**3014**

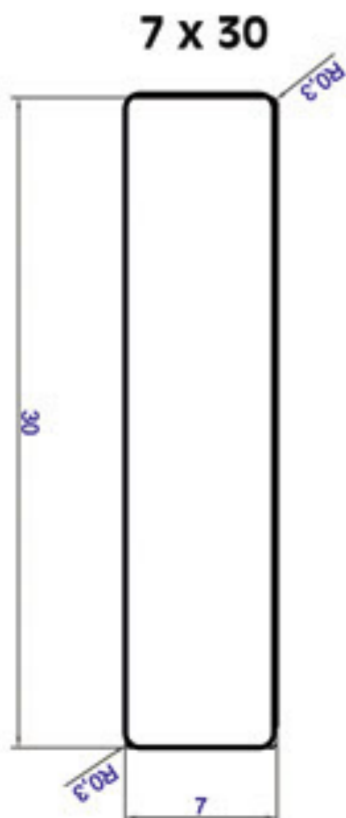
Aras	Ölçü	Siyah	Krom	İnox	Altın
Code : 3014	128 mm	107,93	107,93	118,72	136,53
 50	160 mm	119,15	119,15	131,06	150,72
	192 mm	131,34	131,34	144,47	166,14
	224 mm	146,45	146,45	161,09	185,25
	256 mm	172,24	172,24	189,47	217,89
	288 mm	185,89	185,89	204,48	235,15
	320 mm	199,54	199,54	219,49	252,42
	352 mm	235,06	235,06	258,56	297,35
	416 mm	252,76	252,76	278,03	319,74
	416 mm	275,31	275,31	302,85	348,27
	448 mm	293,01	293,01	322,31	370,66
	480 mm	313,95	313,95	345,35	397,15
	512 mm	326,79	326,79	359,47	413,39





# ALUMİNYUM CNC

## Aluminium Cnc



**Turkuaz** 50  
3015

- Siyah
- Krom
- İnox
- Altın



Aras	ÖLÇÜ / mm		Siyah	Krom	İnox	Altın
Code : 3015	128 mm	50	97,78	97,78	107,55	118,31
50	160 mm	50	111,16	111,16	117,38	129,12
	192 mm	50	121,14	121,14	127,92	140,71
	224 mm	50	139,90	139,90	147,73	162,50
	256 mm	50	150,55	150,55	158,98	174,88
	288 mm	50	160,53	160,53	169,52	186,48
	320 mm	50	178,95	178,95	188,98	207,87
	352 mm	50	200,41	200,41	211,63	237,80
	384 mm	50	215,12	215,12	227,16	249,88
	416 mm	50	231,51	231,51	244,48	268,92
	448 mm	50	244,53	244,53	258,23	284,05
	480 mm	50	257,55	257,55	271,97	299,17
	512 mm	50	279,01	279,01	294,63	324,10

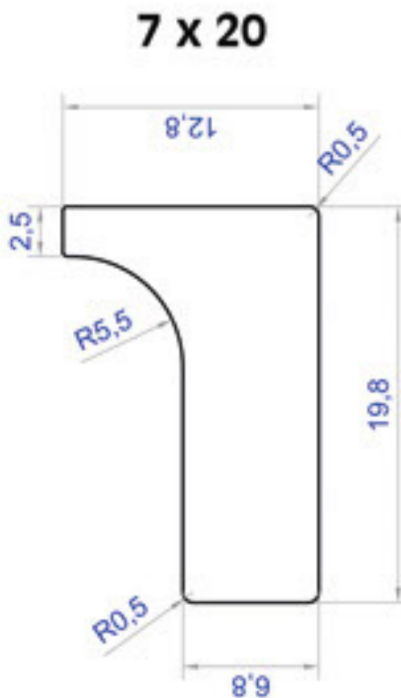

ALM  
CNC

106



**50**
**Sultan**
**3016**

Siyah ●

Krom ●

İnox ●

Altın ●

**ÖLÇÜ / mm**

Code : 3016

 50

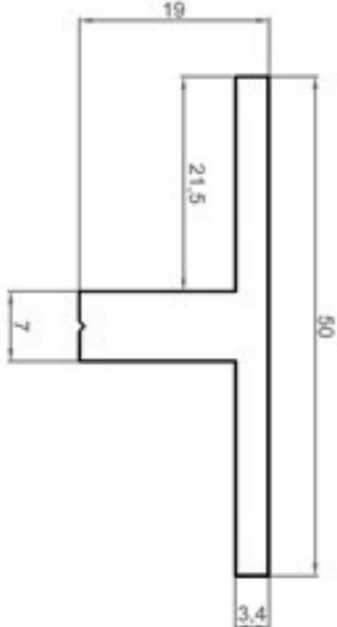
**7 x 50**

ÖLÇÜ / mm		Siyah	Krom	İnox	Altın
128 mm	50	121,75	121,75	131,49	142,00
160 mm	50	137,31	137,31	148,30	160,16
192 mm	50	153,38	153,38	165,65	178,90
224 mm	50	179,75	179,75	194,13	209,66
256 mm	50	195,48	195,48	211,12	228,01
288 mm	50	211,21	211,21	228,11	246,36
320 mm	50	233,69	233,69	252,39	272,58
352 mm	50	259,22	259,22	279,95	302,35
384 mm	50	279,50	279,50	301,86	326,01
416 mm	50	309,24	309,24	333,98	360,70
448 mm	50	324,98	324,98	350,97	379,05
480 mm	50	340,71	340,71	367,97	397,40
512 mm	50	363,19	363,19	392,25	423,63

# ALUMİNYUM CNC

## Aluminium Cnc



Zümrüt 50

3017

- Siyah
- Krom
- İnox
- Altın



ÖLÇÜ / mm			Siyah	Krom	İnox	Altın
Code : 3017	128 mm	50	121,75	121,75	131,49	142,00
50	160 mm	50	137,31	137,31	148,30	160,16
	192 mm	50	153,38	153,38	165,65	178,90
7 x 50	224 mm	50	179,75	179,75	194,13	209,66
	256 mm	50	195,48	195,48	211,12	228,01
	288 mm	50	211,21	211,21	228,11	246,36
	320 mm	50	233,69	233,69	252,39	272,58
	352 mm	50	259,22	259,22	279,95	302,35
	384 mm	50	279,50	279,50	301,86	326,01
	416 mm	50	309,24	309,24	333,98	360,70
	448 mm	50	324,98	324,98	350,97	379,05
	480 mm	50	340,71	340,71	367,97	397,40
	512 mm	50	363,19	363,19	392,25	423,63

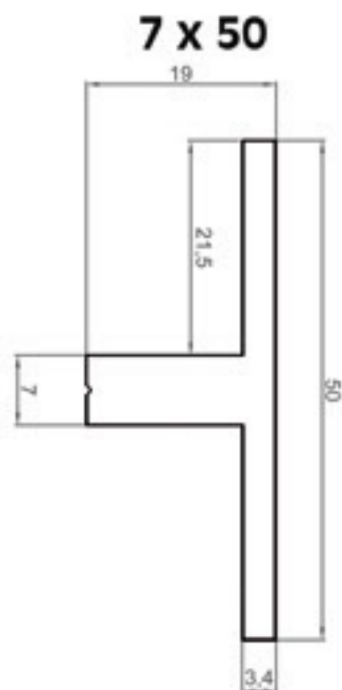

ALM  
CNC

108





**50 Zarafet**
**3018**

- Siyah ●
- Krom ●
- İnox ●
- Altın ●

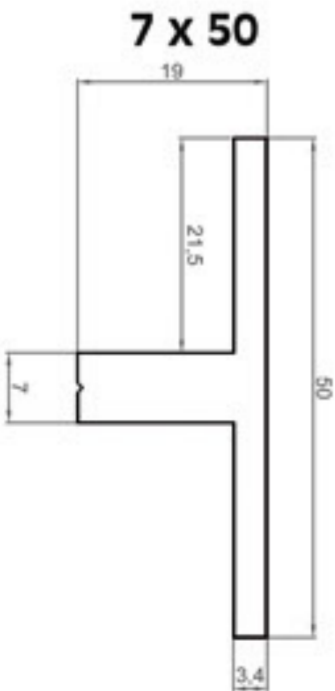

ÖLÇÜ / mm		Siyah	Krom	İnox	Altın	
Code : 3018	128 mm	50	121,75	121,75	131,49	142,00
50	160 mm	50	137,31	137,31	148,30	160,16
	192 mm	50	153,38	153,38	165,65	178,90
7 x 50	224 mm	50	179,75	179,75	194,13	209,66
	256 mm	50	195,48	195,48	211,12	228,01
	288 mm	50	211,21	211,21	228,11	246,36
	320 mm	50	233,69	233,69	252,39	272,58
	352 mm	50	259,22	259,22	279,95	302,35
	384 mm	50	279,50	279,50	301,86	326,01
	416 mm	50	309,24	309,24	333,98	360,70
	448 mm	50	324,98	324,98	350,97	379,05
	480 mm	50	340,71	340,71	367,97	397,40
	512 mm	50	363,19	363,19	392,25	423,63



# ALUMİNYUM CNC

## Aluminium Cnc



Stil 50

3019

- Siyah
- Krom
- İnox
- Altın

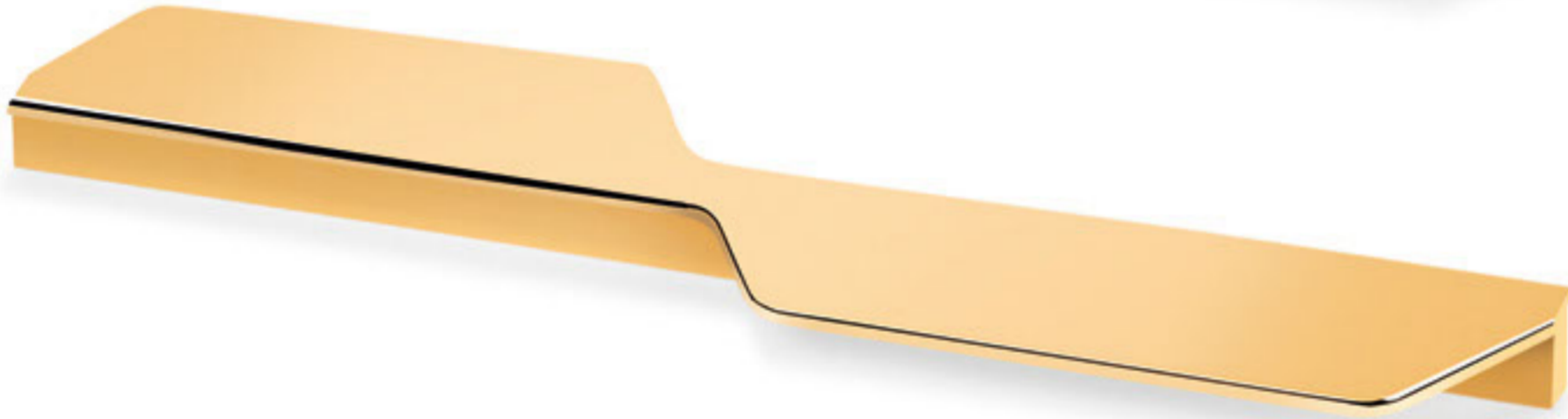

ÖLÇÜ / mm			Siyah	Krom	İnox	Altın
Code : 3019	128 mm	50	121,75	121,75	131,49	142,00
50	160 mm	50	137,31	137,31	148,30	160,16
7 x 50	192 mm	50	153,38	153,38	165,65	178,90
	224 mm	50	179,75	179,75	194,13	209,66
	256 mm	50	195,48	195,48	211,12	228,01
	288 mm	50	211,21	211,21	228,11	246,36
	320 mm	50	233,69	233,69	252,39	272,58
	352 mm	50	259,22	259,22	279,95	302,35
	384 mm	50	279,50	279,50	301,86	326,01
	416 mm	50	309,24	309,24	333,98	360,70
	448 mm	50	324,98	324,98	350,97	379,05
	480 mm	50	340,71	340,71	367,97	397,40
	512 mm	50	363,19	363,19	392,25	423,63

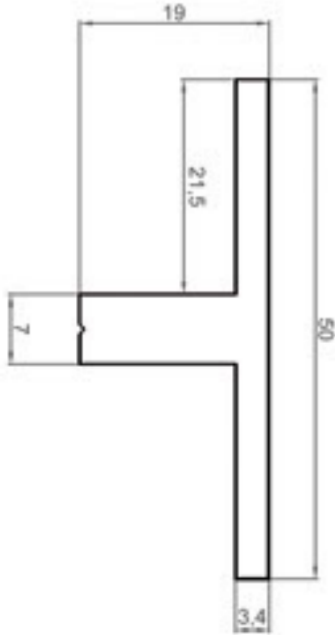

ALM  
CNC

110



**50 Yakamoz**
**3020**

- Siyah ●
- Krom ●
- İnox ●
- Altın ●



ÖLÇÜ / mm			Siyah	Krom	İnox	Altın
Code : 3020	128 mm	50	121,75	121,75	131,49	142,00
 50	160 mm	50	137,31	137,31	148,30	160,16
7 x 50	192 mm	50	153,38	153,38	165,65	178,90
	224 mm	50	179,75	179,75	194,13	209,66
	256 mm	50	195,48	195,48	211,12	228,01
	288 mm	50	211,21	211,21	228,11	246,36
	320 mm	50	233,69	233,69	252,39	272,58
	352 mm	50	259,22	259,22	279,95	302,35
	384 mm	50	279,50	279,50	301,86	326,01
	416 mm	50	309,24	309,24	333,98	360,70
	448 mm	50	324,98	324,98	350,97	379,05
	480 mm	50	340,71	340,71	367,97	397,40
	512 mm	50	363,19	363,19	392,25	423,63

# ALUMİNYUM CNC

## Aluminium Cnc



Safir 50

3021

- Siyah
- Krom
- İnox
- Altın



ÖLÇÜ / mm		Siyah	Krom	İnox	Altın	
Code : 3021	128 mm	50	121,75	121,75	131,49	142,00
50	160 mm	50	137,31	137,31	148,30	160,16
7 x 50	192 mm	50	153,38	153,38	165,65	178,90
	224 mm	50	179,75	179,75	194,13	209,66
	256 mm	50	195,48	195,48	211,12	228,01
	288 mm	50	211,21	211,21	228,11	246,36
	320 mm	50	233,69	233,69	252,39	272,58
	352 mm	50	259,22	259,22	279,95	302,35
	384 mm	50	279,50	279,50	301,86	326,01
	416 mm	50	309,24	309,24	333,98	360,70
	448 mm	50	324,98	324,98	350,97	379,05
	480 mm	50	340,71	340,71	367,97	397,40
	512 mm	50	363,19	363,19	392,25	423,63

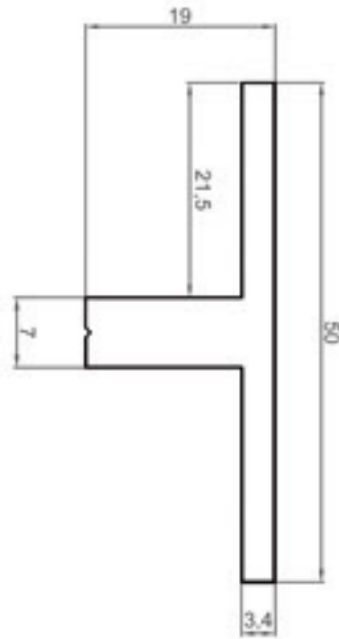

ALM  
CNC

112





50 Kıvılcım

3022

- Siyah ●
- Krom ●
- İnox ●
- Altın ●



ÖLÇÜ / mm		Siyah	Krom	İnox	Altın
Code : 3022					
50					
7 x 50					
					
128 mm	50	121,75	121,75	131,49	142,00
160 mm	50	137,31	137,31	148,30	160,16
192 mm	50	153,38	153,38	165,65	178,90
224 mm	50	179,75	179,75	194,13	209,66
256 mm	50	195,48	195,48	211,12	228,01
288 mm	50	211,21	211,21	228,11	246,36
320 mm	50	233,69	233,69	252,39	272,58
352 mm	50	259,22	259,22	279,95	302,35
384 mm	50	279,50	279,50	301,86	326,01
416 mm	50	309,24	309,24	333,98	360,70
448 mm	50	324,98	324,98	350,97	379,05
480 mm	50	340,71	340,71	367,97	397,40
512 mm	50	363,19	363,19	392,25	423,63

# ALUMİNYUM CNC

## Aluminium Cnc



Damla 50

3023

- Siyah
- Krom
- İnox
- Altın



ÖLÇÜ / mm		Siyah	Krom	İnox	Altın
Code : 3023	128 mm	121,75	121,75	131,49	142,00
50	160 mm	137,31	137,31	148,30	160,16
7 x 50	192 mm	153,38	153,38	165,65	178,90
	224 mm	179,75	179,75	194,13	209,66
	256 mm	195,48	195,48	211,12	228,01
	288 mm	211,21	211,21	228,11	246,36
	320 mm	233,69	233,69	252,39	272,58
	352 mm	259,22	259,22	279,95	302,35
	384 mm	279,50	279,50	301,86	326,01
	416 mm	309,24	309,24	333,98	360,70
	448 mm	324,98	324,98	350,97	379,05
	480 mm	340,71	340,71	367,97	397,40
	512 mm	363,19	363,19	392,25	423,63

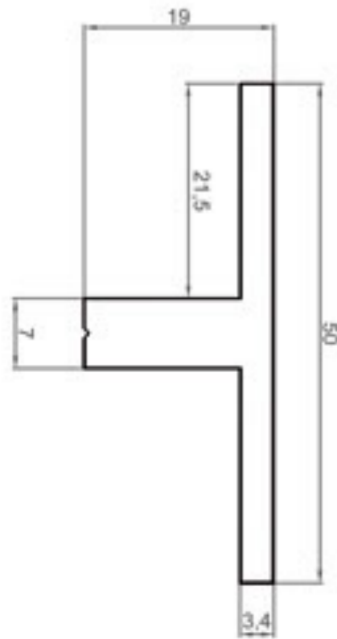

ALM  
CNC

114





**50 İnci**

- Siyah ●  
 Krom ●  
 İnox ●  
 Altın ●

**3024**

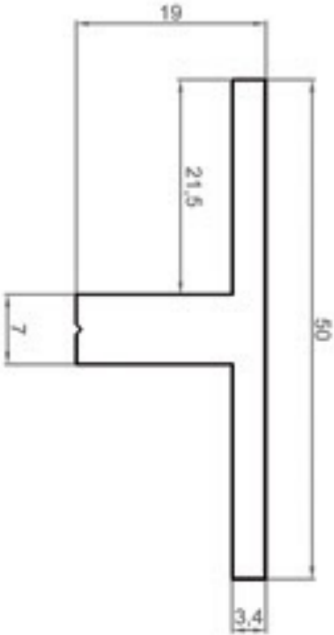
ÖLÇÜ / mm		📦	Siyah	Krom	İnox	Altın
Code : 3024 📦 50	128 mm	50	121,75	121,75	131,49	142,00
	160 mm	50	137,31	137,31	148,30	160,16
	192 mm	50	153,38	153,38	165,65	178,90
	224 mm	50	179,75	179,75	194,13	209,66
	256 mm	50	195,48	195,48	211,12	228,01
	288 mm	50	211,21	211,21	228,11	246,36
	320 mm	50	233,69	233,69	252,39	272,58
	352 mm	50	259,22	259,22	279,95	302,35
	384 mm	50	279,50	279,50	301,86	326,01
	416 mm	50	309,24	309,24	333,98	360,70
	448 mm	50	324,98	324,98	350,97	379,05
	480 mm	50	340,71	340,71	367,97	397,40
	512 mm	50	363,19	363,19	392,25	423,63

**7 x 50**

# ALUMİNYUM CNC

## Aluminium Cnc



Linea 50

3025

- Siyah
- Krom
- Inox
- Altın

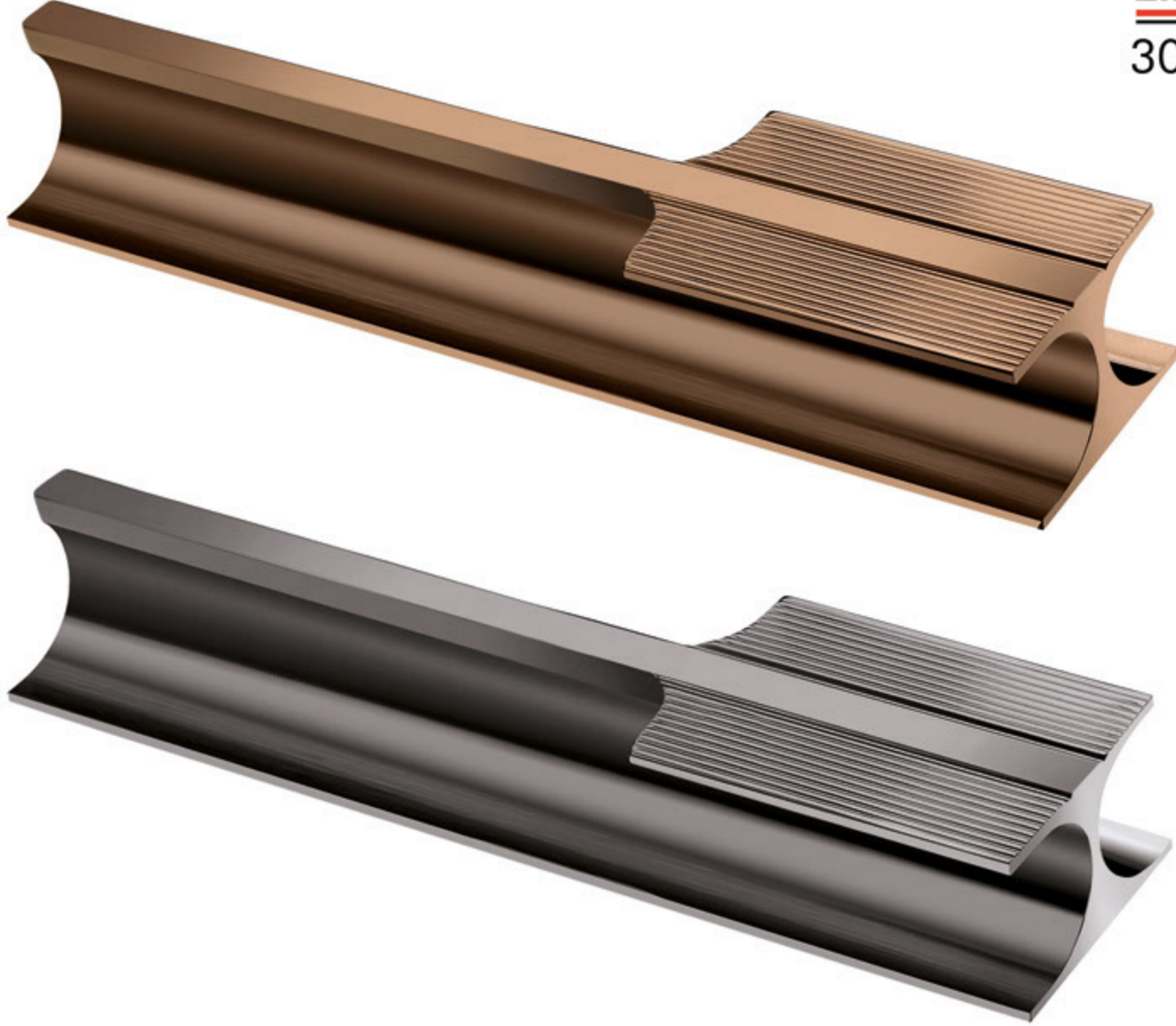

ÖLÇÜ / mm		Siyah	Krom	Altın
Code : 3025	160 mm	194,07	194,07	226,97
50	192 mm	218,60	218,60	256,99
	224 mm	243,13	243,13	287,01
	256 mm	283,70	283,70	333,06
	288 mm	309,07	309,07	363,92
	320 mm	336,14	336,14	396,47
	352 mm	378,39	378,39	444,20
	384 mm	408,83	408,83	480,13
	416 mm	439,27	439,27	516,05
	448 mm	478,15	478,15	560,41
	480 mm	508,58	508,58	596,33
	512 mm	539,02	539,02	632,26

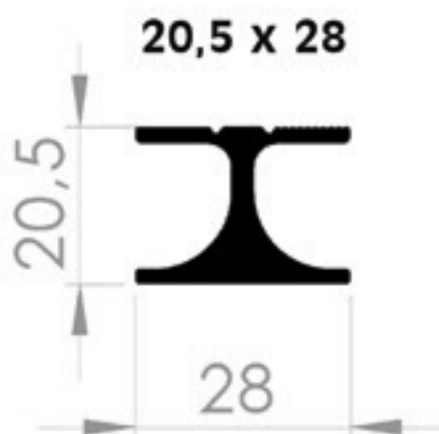

ALM  
CNC

116



**Harmony**

3026

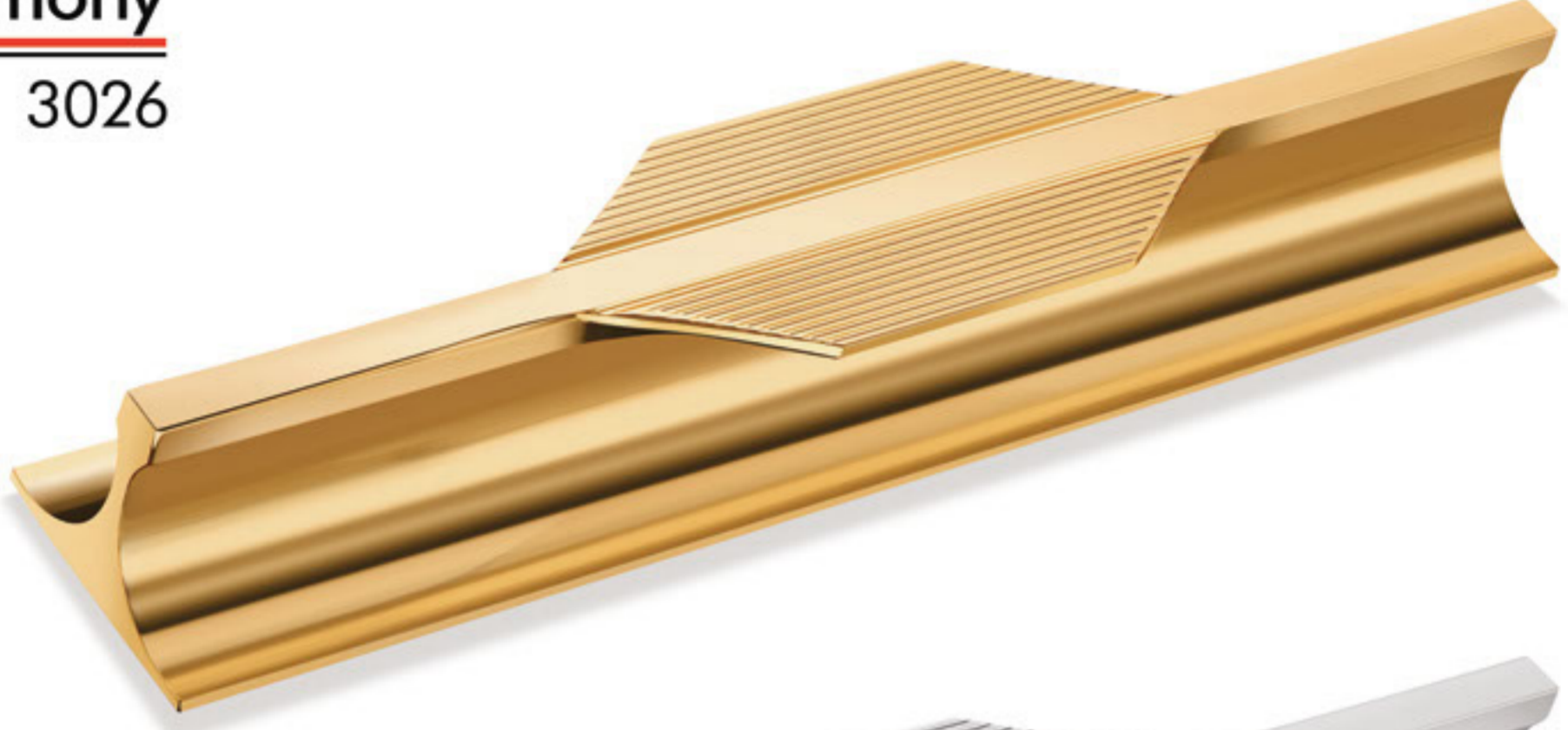

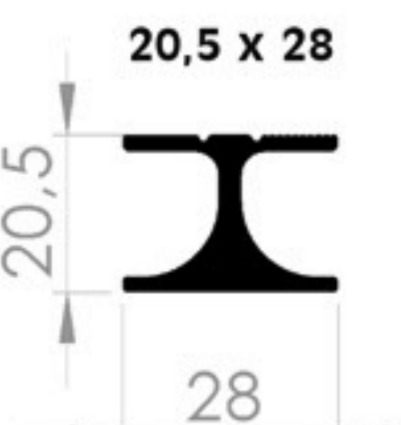
ÖLÇÜ / mm		Siyah	Krom	Altın	
<b>Code : 3026</b>  50 	160 mm	50	194,07	194,07	226,97
	192 mm	50	218,60	218,60	256,99
	224 mm	50	243,13	243,13	287,01
	256 mm	50	283,70	283,70	333,06
	288 mm	50	309,07	309,07	363,92
	320 mm	50	336,14	336,14	396,47
	352 mm	50	378,39	378,39	444,20
	384 mm	50	408,83	408,83	480,13
	416 mm	50	439,27	439,27	516,05
	448 mm	50	478,15	478,15	560,41
	480 mm	50	508,58	508,58	596,33
	512 mm	50	539,02	539,02	632,26





**Aventus 50**

**3027**

- Siyah
- Krom
- İnox
- Altın



ÖLÇÜ / mm	📦	Siyah	Krom	Altın
<b>Code : 3027</b>				
📦 50				
32 mm	50	104,50	104,50	118,21
64 mm	50	124,35	124,35	140,80
96 mm	50	147,37	147,37	169,30
128 mm	50	170,72	170,72	198,14
160 mm	50	194,07	194,07	226,97
192 mm	50	218,60	218,60	256,99
224 mm	50	243,13	243,13	287,01
256 mm	50	283,70	283,70	333,06
288 mm	50	309,07	309,07	363,92
320 mm	50	336,14	336,14	396,47
352 mm	50	378,39	378,39	444,20
384 mm	50	408,83	408,83	480,13
416 mm	50	439,27	439,27	516,05
448 mm	50	478,15	478,15	560,41
480 mm	50	508,58	508,58	596,33
512 mm	50	539,02	539,02	632,26

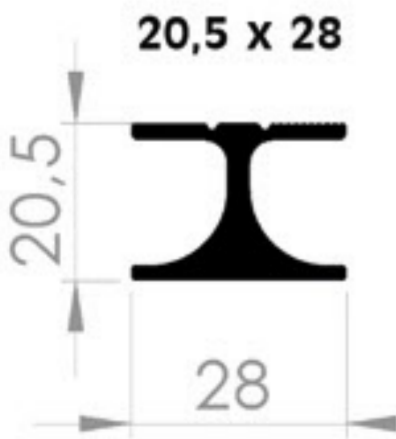





**50 Urban**

- Siyah ●  
 Krom ●  
 Inox ●  
 Altın ●

**3028**

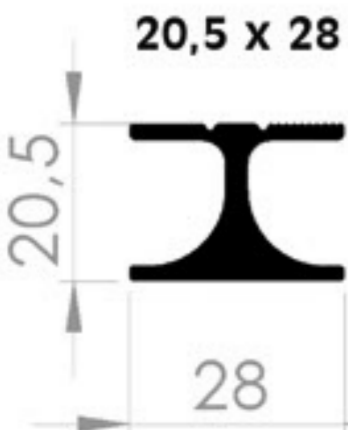
ÖLÇÜ / mm		Siyah	Krom	Altın	
Code : 3028	160 mm	50	194,07	194,07	226,97
 50	192 mm	50	218,60	218,60	256,99
	224 mm	50	243,13	243,13	287,01
	256 mm	50	283,70	283,70	333,06
	288 mm	50	309,07	309,07	363,92
	320 mm	50	336,14	336,14	396,47
	352 mm	50	378,39	378,39	444,20
	384 mm	50	408,83	408,83	480,13
	416 mm	50	439,27	439,27	516,05
	448 mm	50	478,15	478,15	560,41
	480 mm	50	508,58	508,58	596,33
	512 mm	50	539,02	539,02	632,26





# ALUMİNYUM CNC

## Aluminium Cnc



Artisan 50

3029

- Siyah
- Krom
- İnox
- Altın



ÖLÇÜ / mm		Siyah	Krom	Altın
Code : 3029	32 mm	104,50	104,50	118,21
50	64 mm	124,35	124,35	140,80
	96 mm	147,37	147,37	169,30
	128 mm	170,72	170,72	198,14
	160 mm	194,07	194,07	226,97
	192 mm	218,60	218,60	256,99
	224 mm	243,13	243,13	287,01
	256 mm	283,70	283,70	333,06
	288 mm	309,07	309,07	363,92
	320 mm	336,14	336,14	396,47
	352 mm	378,39	378,39	444,20
	384 mm	408,83	408,83	480,13
	416 mm	439,27	439,27	516,05
	448 mm	478,15	478,15	560,41
	480 mm	508,58	508,58	596,33
	512 mm	539,02	539,02	632,26

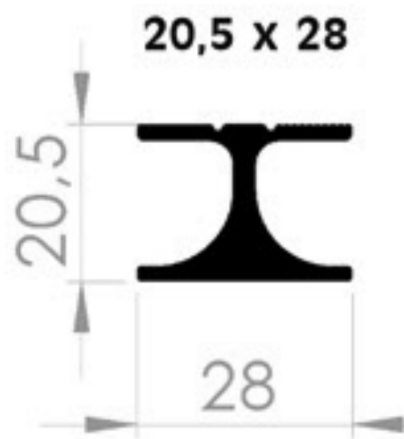

ALM  
CNC

120





**50 Orion**

- Siyah ●
- Krom ●
- Inox ●
- Altın ●

**3030**

**ÖLÇÜ / mm**

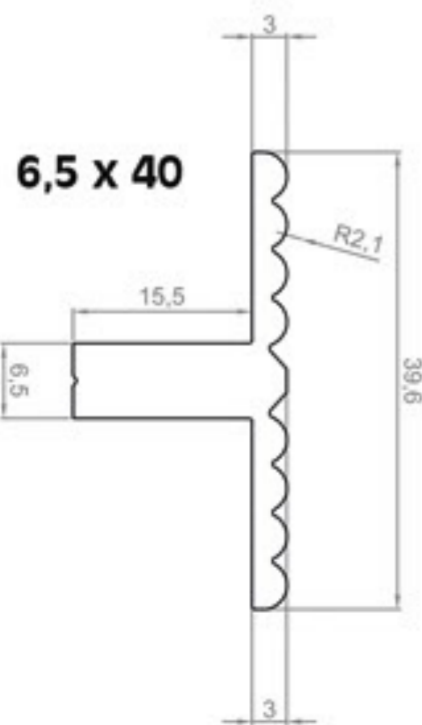
Code : 3030

 50

ÖLÇÜ / mm		Siyah	Krom	Altın
128 mm	50	108,48	108,48	142,00
160 mm	50	121,06	121,06	160,16
192 mm	50	134,14	134,14	178,90
224 mm	50	157,52	157,52	209,66
256 mm	50	170,26	170,26	228,01
288 mm	50	183,00	183,00	246,36
320 mm	50	202,50	202,50	272,58
352 mm	50	225,03	225,03	302,35
384 mm	50	242,33	242,33	326,00
416 mm	50	269,08	269,08	360,70
448 mm	50	281,82	281,82	379,05
480 mm	50	294,57	294,57	397,40
512 mm	50	314,06	314,06	423,63



# ALUMİNYUM CNC

## Aluminium Cnc



Opus 50

3031

- Siyah
- Krom
- Inox
- Altın



ÖLÇÜ / mm		Siyah	Krom	Altın
Code : 3031				
50				
128 mm	50	108,48	108,48	142,00
160 mm	50	121,06	121,06	160,16
192 mm	50	134,14	134,14	178,90
224 mm	50	157,52	157,52	209,66
256 mm	50	170,26	170,26	228,01
288 mm	50	183,00	183,00	246,36
320 mm	50	202,50	202,50	272,58
352 mm	50	225,03	225,03	302,35
384 mm	50	242,33	242,33	326,00
416 mm	50	269,08	269,08	360,70
448 mm	50	281,82	281,82	379,05
480 mm	50	294,57	294,57	397,40
512 mm	50	314,06	314,06	423,63

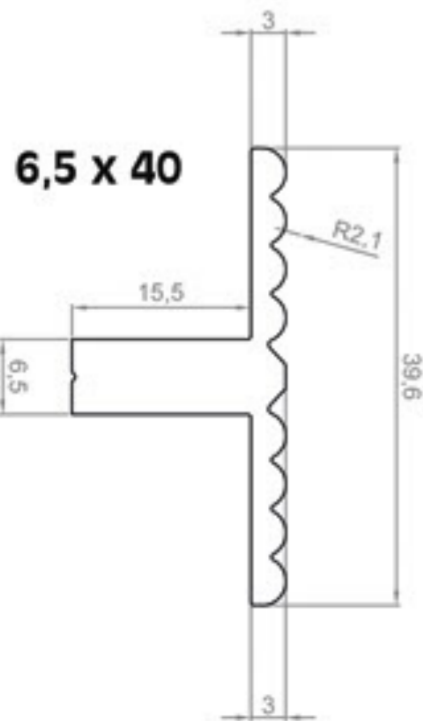

ALM  
CNC

122



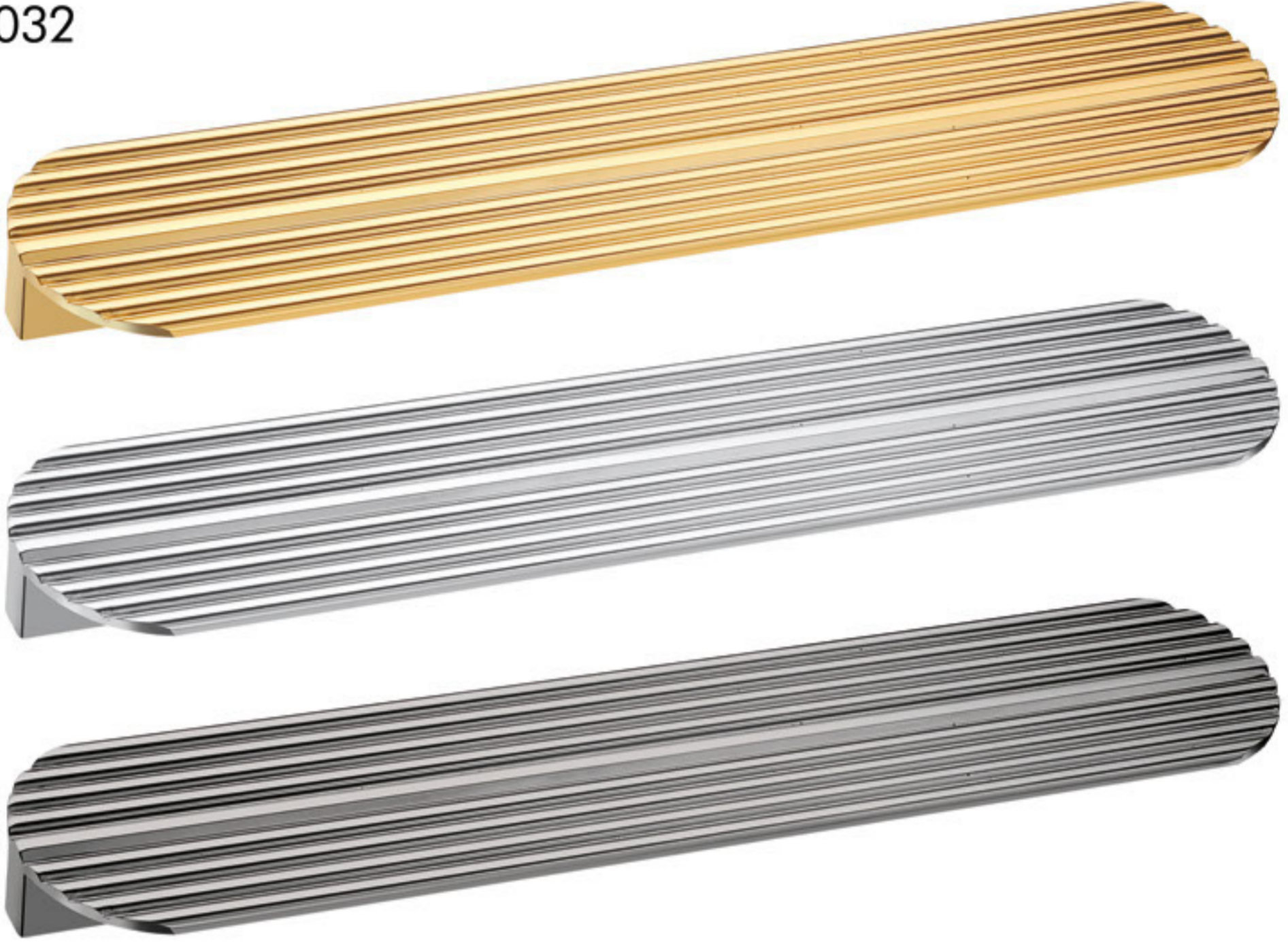

**50 Terra**

- Siyah ●
- Krom ●
- Inox ●
- Altın ●

**3032**

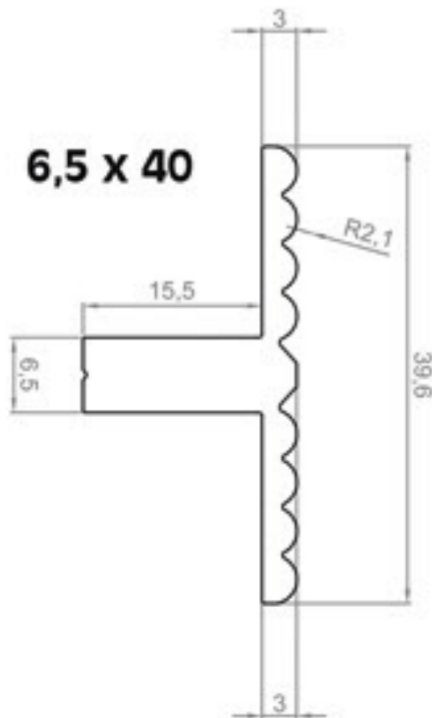
**ÖLÇÜ / mm**

Code : 3032

 50

ÖLÇÜ / mm		Siyah	Krom	Altın
128 mm	50	108,48	108,48	142,00
160 mm	50	121,06	121,06	160,16
192 mm	50	134,14	134,14	178,90
224 mm	50	157,52	157,52	209,66
256 mm	50	170,26	170,26	228,01
288 mm	50	183,00	183,00	246,36
320 mm	50	202,50	202,50	272,58
352 mm	50	225,03	225,03	302,35
384 mm	50	242,33	242,33	326,00
416 mm	50	269,08	269,08	360,70
448 mm	50	281,82	281,82	379,05
480 mm	50	294,57	294,57	397,40
512 mm	50	314,06	314,06	423,63



# ALUMİNYUM CNC

## Aluminium Cnc



Enigma 50

3033

- Siyah
- Krom
- Inox
- Altın



### ÖLÇÜ / mm

Code : 3033

50

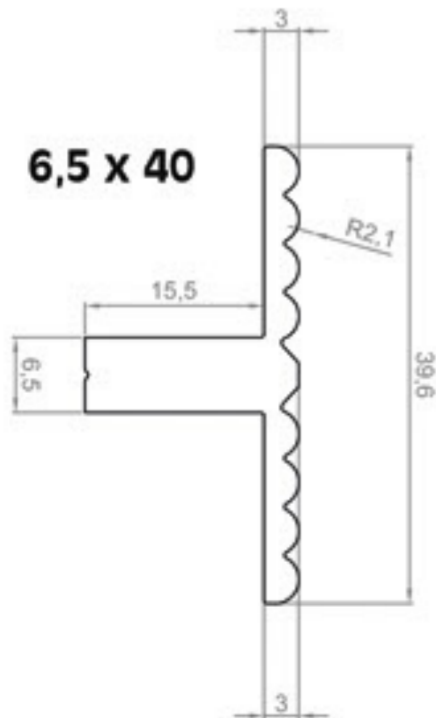

ÖLÇÜ / mm	50	Siyah	Krom	Altın
128 mm	50	108,48	108,48	142,00
160 mm	50	121,06	121,06	160,16
192 mm	50	134,14	134,14	178,90
224 mm	50	157,52	157,52	209,66
256 mm	50	170,26	170,26	228,01
288 mm	50	183,00	183,00	246,36
320 mm	50	202,50	202,50	272,58
352 mm	50	225,03	225,03	302,35
384 mm	50	242,33	242,33	326,00
416 mm	50	269,08	269,08	360,70
448 mm	50	281,82	281,82	379,05
480 mm	50	294,57	294,57	397,40
512 mm	50	314,06	314,06	423,63

ALM  
CNC

124





**50 Opal**

- Siyah ●
- Krom ●
- Inox ●
- Altın ●

**3034**

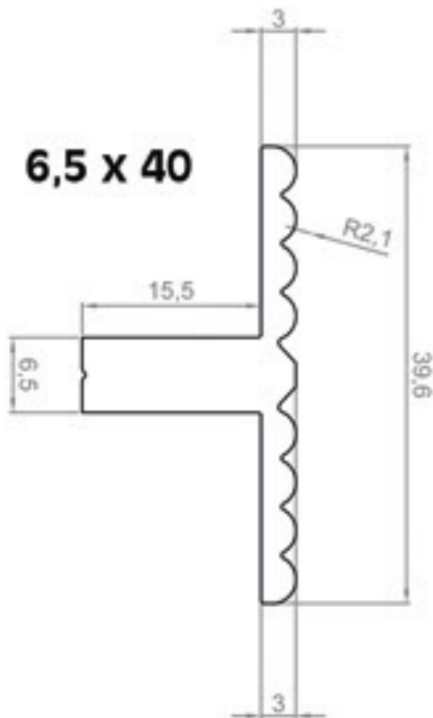
ÖLÇÜ / mm		Siyah	Krom	Altın
Code : 3034				
 50				
128 mm	50	108,48	108,48	142,00
160 mm	50	121,06	121,06	160,16
192 mm	50	134,14	134,14	178,90
224 mm	50	157,52	157,52	209,66
256 mm	50	170,26	170,26	228,01
288 mm	50	183,00	183,00	246,36
320 mm	50	202,50	202,50	272,58
352 mm	50	225,03	225,03	302,35
384 mm	50	242,33	242,33	326,00
416 mm	50	269,08	269,08	360,70
448 mm	50	281,82	281,82	379,05
480 mm	50	294,57	294,57	397,40
512 mm	50	314,06	314,06	423,63







Lumina 50

3035

- Siyah
- Krom
- İnox
- Altın



ÖLÇÜ / mm		Siyah	Krom	Altın
Code : 3035				
50				
128 mm	50	108,48	108,48	142,00
160 mm	50	121,06	121,06	160,16
192 mm	50	134,14	134,14	178,90
224 mm	50	157,52	157,52	209,66
256 mm	50	170,26	170,26	228,01
288 mm	50	183,00	183,00	246,36
320 mm	50	202,50	202,50	272,58
352 mm	50	225,03	225,03	302,35
384 mm	50	242,33	242,33	326,00
416 mm	50	269,08	269,08	360,70
448 mm	50	281,82	281,82	379,05
480 mm	50	294,57	294,57	397,40
512 mm	50	314,06	314,06	423,63

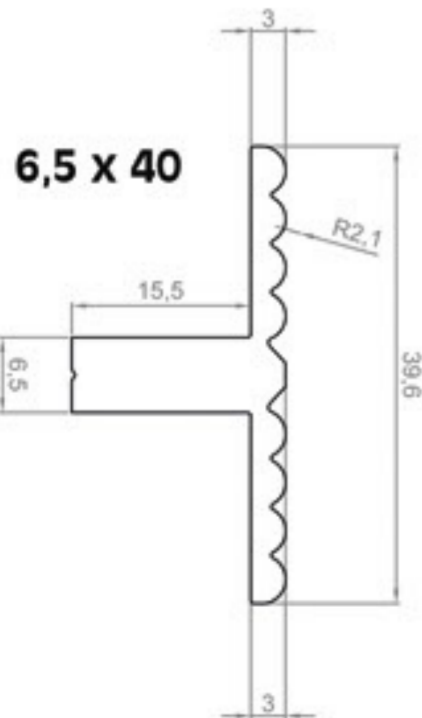





**50 Phoenix**
**3036**

Siyah ●

Krom ●

Inox ●

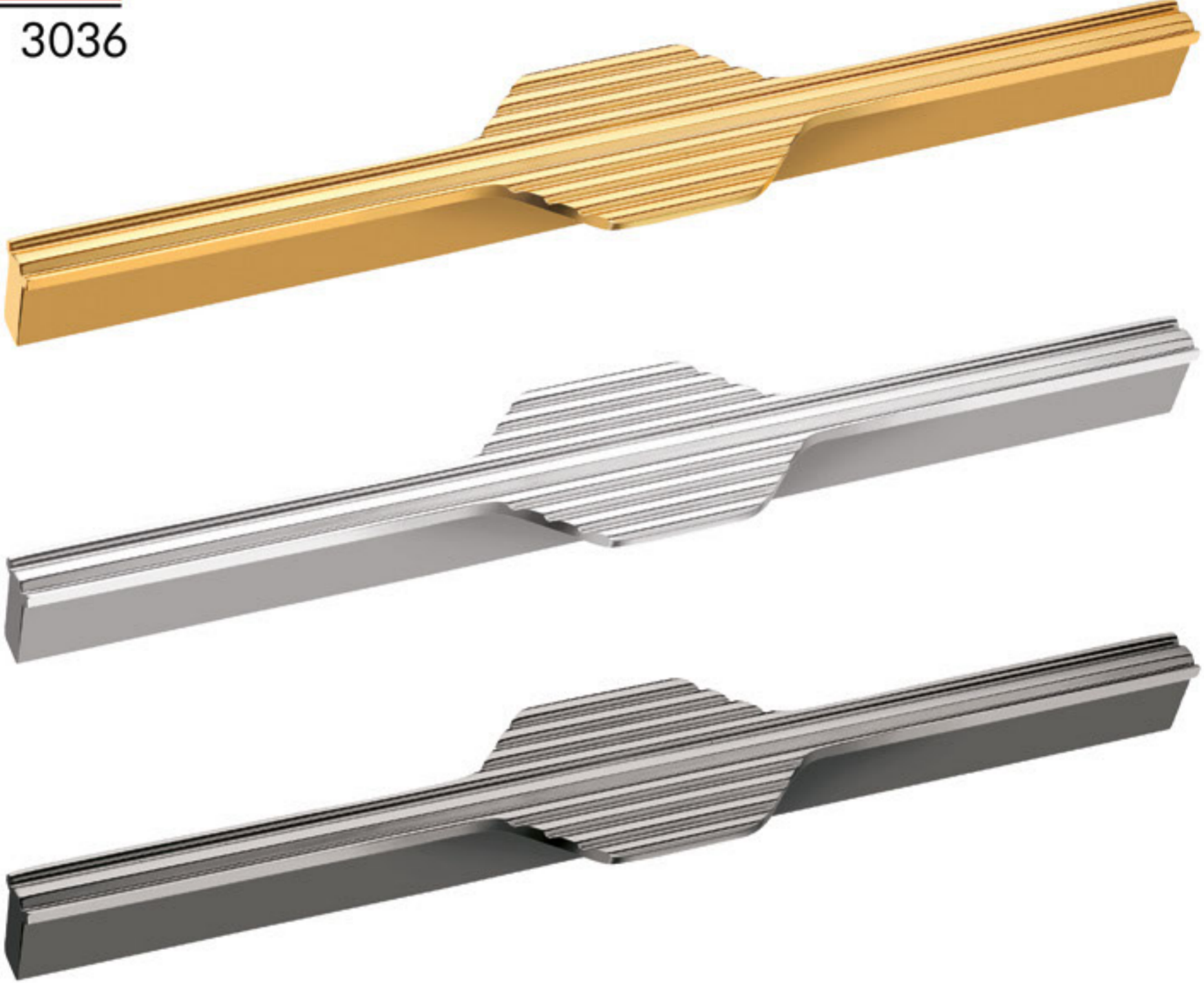
Altın ●

**ÖLÇÜ / mm**

Code : 3036

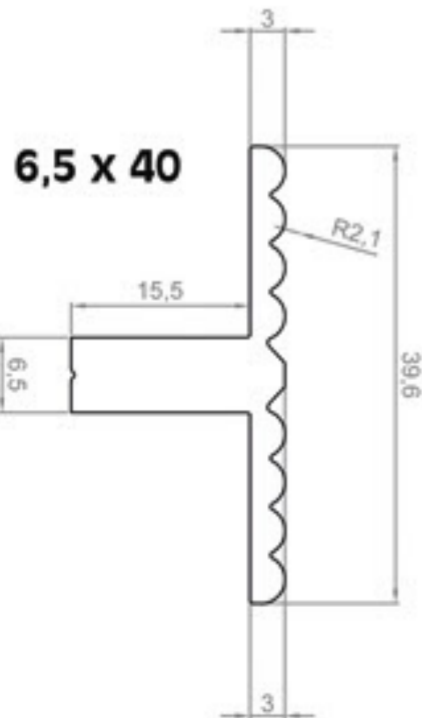
 50

ÖLÇÜ / mm		Siyah	Krom	Altın
128 mm	50	108,48	108,48	142,00
160 mm	50	121,06	121,06	160,16
192 mm	50	134,14	134,14	178,90
224 mm	50	157,52	157,52	209,66
256 mm	50	170,26	170,26	228,01
288 mm	50	183,00	183,00	246,36
320 mm	50	202,50	202,50	272,58
352 mm	50	225,03	225,03	302,35
384 mm	50	242,33	242,33	326,00
416 mm	50	269,08	269,08	360,70
448 mm	50	281,82	281,82	379,05
480 mm	50	294,57	294,57	397,40
512 mm	50	314,06	314,06	423,63



# ALUMİNYUM CNC

## Aluminium Cnc



Verona 50  
3037

- Siyah
- Krom
- İnox
- Altın



ÖLÇÜ / mm		Siyah	Krom	Altın
Code : 3037				
50				
128 mm	50	108,48	108,48	142,00
160 mm	50	121,06	121,06	160,16
192 mm	50	134,14	134,14	178,90
224 mm	50	157,52	157,52	209,66
256 mm	50	170,26	170,26	228,01
288 mm	50	183,00	183,00	246,36
320 mm	50	202,50	202,50	272,58
352 mm	50	225,03	225,03	302,35
384 mm	50	242,33	242,33	326,00
416 mm	50	269,08	269,08	360,70
448 mm	50	281,82	281,82	379,05
480 mm	50	294,57	294,57	397,40
512 mm	50	314,06	314,06	423,63

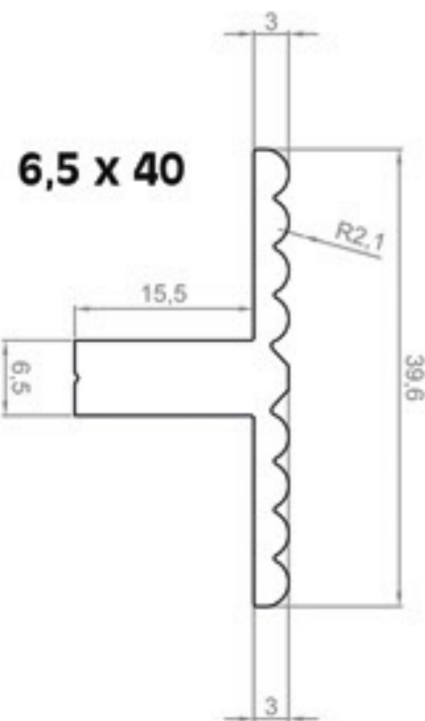

ALM  
CNC

128



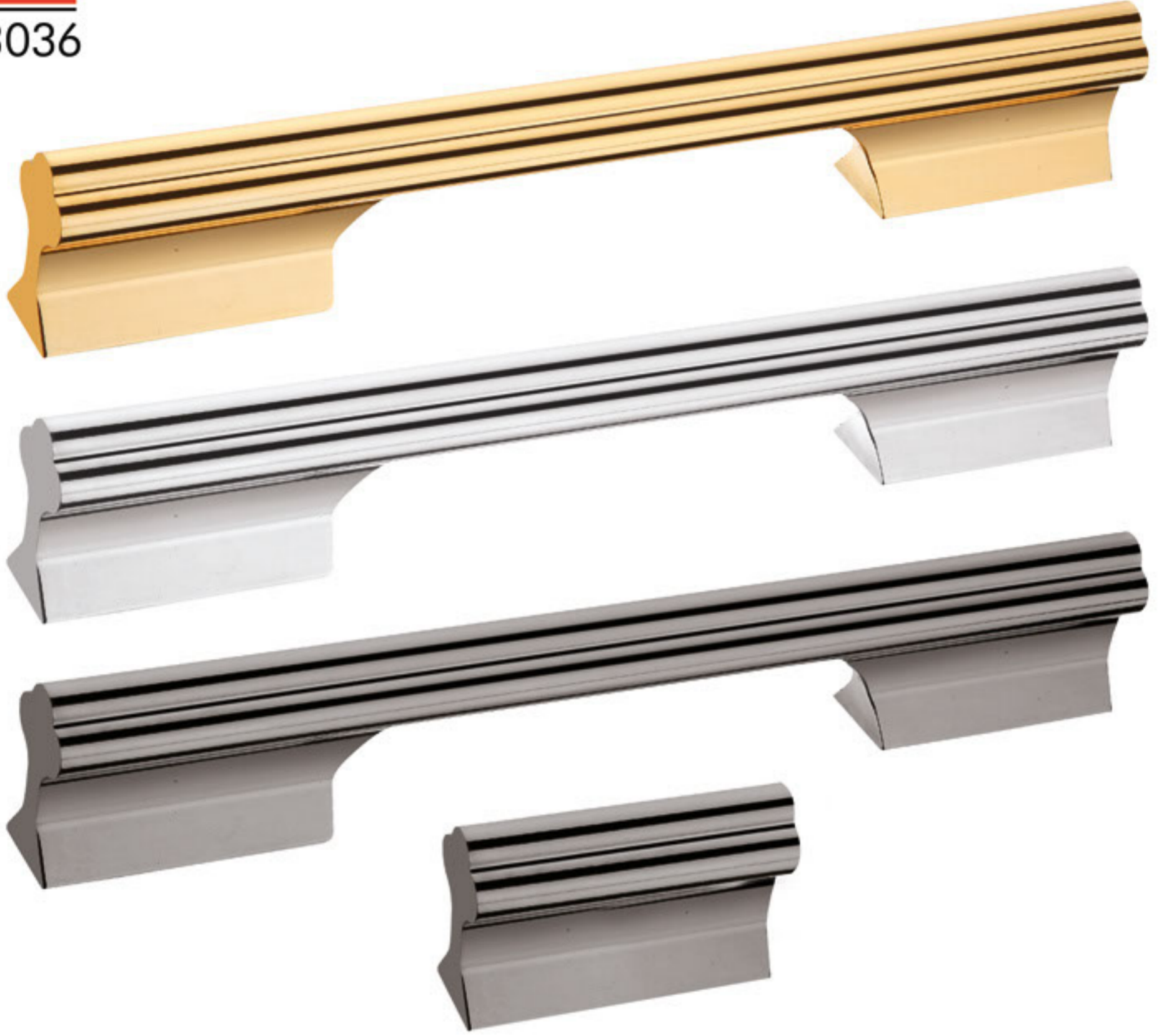

**50 Vesta**
**3036**

- Siyah ●
- Krom ●
- Inox ●
- Altın ●

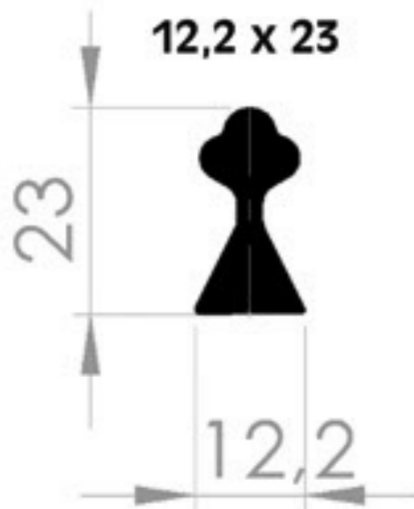

ÖLÇÜ / mm		Siyah	Krom	Altın
Code : 3036				
 50				
32 mm	50	65,30	65,30	73,74
128 mm	50	203,80	203,80	222,25
160 mm	50	227,43	227,43	250,21
192 mm	50	250,64	250,64	274,79
224 mm	50	273,86	273,86	299,38
256 mm	50	297,92	297,92	324,80
288 mm	50	325,17	325,17	357,06
320 mm	50	363,13	363,13	407,55
352 mm	50	406,79	406,79	455,09
384 mm	50	435,91	435,91	485,57
416 mm	50	468,75	468,75	519,78
448 mm	50	497,87	497,87	550,27
480 mm	50	526,99	526,99	580,76
512 mm	50	565,14	565,14	623,23





# ALUMİNYUM CNC

## Aluminium Cnc

# DEĞİŞİM



Gala 50

3037

- Siyah
- Krom
- İnox
- Altın



ÖLÇÜ / mm		Siyah	Krom	Altın
Code : 3037				
50				
32 mm	50	65,30	65,30	73,74
128 mm	50	203,80	203,80	222,25
160 mm	50	227,43	227,43	250,21
192 mm	50	250,64	250,64	274,79
224 mm	50	273,86	273,86	299,38
256 mm	50	297,92	297,92	324,80
288 mm	50	325,17	325,17	357,06
320 mm	50	363,13	363,13	407,55
352 mm	50	406,79	406,79	455,09
384 mm	50	435,91	435,91	485,57
416 mm	50	468,75	468,75	519,78
448 mm	50	497,87	497,87	550,27
480 mm	50	526,99	526,99	580,76
512 mm	50	565,14	565,14	623,23

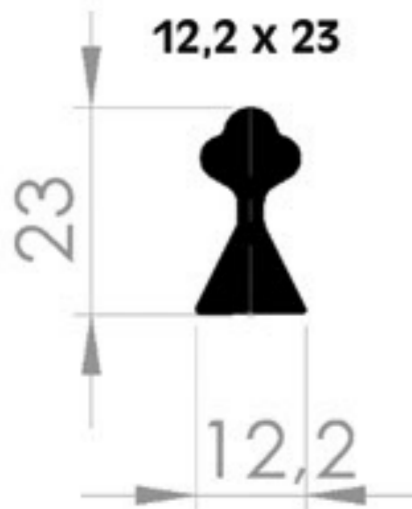

ALM  
CNC

130



**50 Zambak**
**3038**

- Siyah ●
- Krom ●
- İnox ●
- Altın ●

**Zambak**
**Code : 3038**
 50

Ölçü	Siyah	Krom	İnox	Altın
128 mm	97,78	97,78	107,55	118,31
160 mm	111,16	111,16	117,38	129,12
192 mm	121,14	121,14	127,92	140,71
224 mm	139,90	139,90	147,73	162,50
256 mm	150,55	150,55	158,98	174,88
288 mm	160,53	160,53	169,52	186,48
320 mm	178,95	178,95	188,98	207,87
352 mm	200,41	200,41	211,63	232,80
416 mm	215,12	215,12	227,16	249,88
416 mm	231,51	231,51	244,48	268,92
448 mm	244,53	244,53	258,23	284,05
480 mm	257,55	257,55	271,97	299,17
512 mm	279,01	279,01	294,63	324,10

**50 Burak**
**3039**

- Siyah ●
- Krom ●
- İnox ●
- Altın ●

**Burak**
**Code : 3039**
 50

Ölçü	Siyah	Krom	İnox	Altın
128 mm	97,78	97,78	107,55	118,31
160 mm	111,16	111,16	117,38	129,12
192 mm	121,14	121,14	127,92	140,71
224 mm	139,90	139,90	147,73	162,50
256 mm	150,55	150,55	158,98	174,88
288 mm	160,53	160,53	169,52	186,48
320 mm	178,95	178,95	188,98	207,87
352 mm	200,41	200,41	211,63	232,80
416 mm	215,12	215,12	227,16	249,88
416 mm	231,51	231,51	244,48	268,92
448 mm	244,53	244,53	258,23	284,05
480 mm	257,55	257,55	271,97	299,17
512 mm	279,01	279,01	294,63	324,10



# ALUMİNYUM CNC

## Aluminium Cnc



Zeytin 50

3040

● Siyah

● Krom

● İnox

● Altın

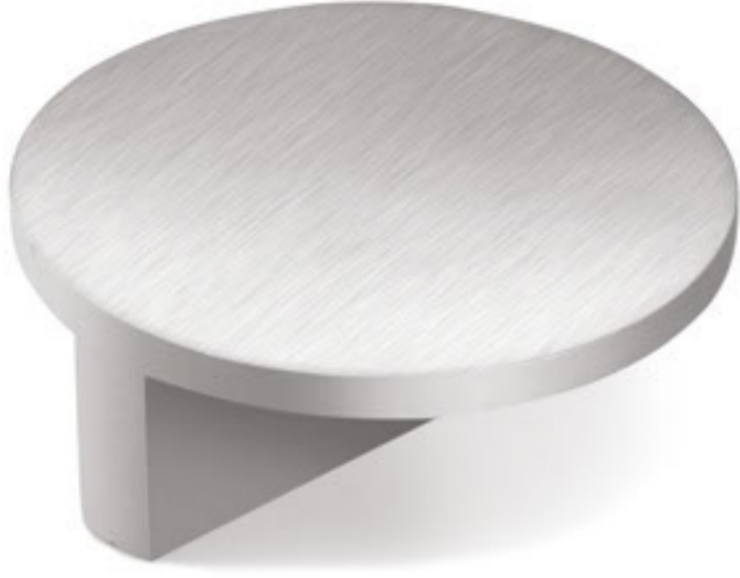

ÖLÇÜ / mm

Code : 3040

50

32 mm



50

Siyah

67,51

Krom

67,51

İnox

72,91

Altın

78,71

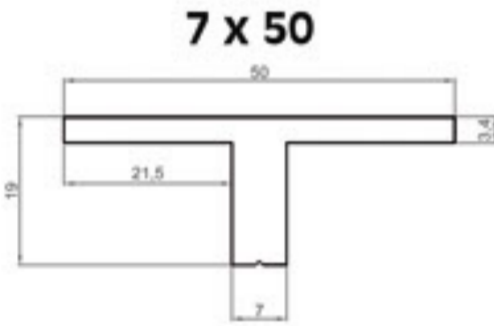

Zinde 50

3041

● Siyah

● Krom

● İnox

● Altın

ÖLÇÜ / mm

Code : 3041

50

32 mm



50

Siyah

67,51

Krom

67,51

İnox

72,91

Altın

78,71



50

ALM  
CNC

132





**50 Toprak**
**3042**

- Siyah ●
- Krom ●
- İnox ●
- Altın ●

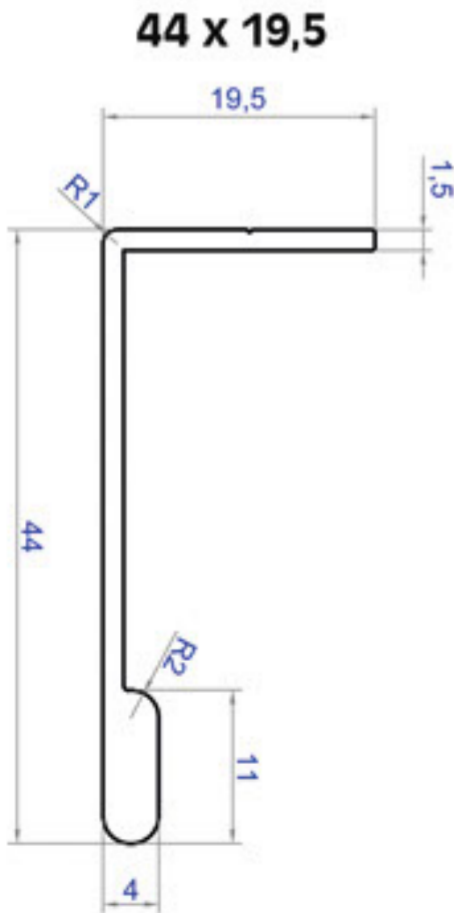

ÖLÇÜ / mm	Box	Siyah	Krom	İnox	Altın
Code : 3042					
Box 50					
47 mm	50	63,55	63,55	68,64	75,54
97 mm	50	84,85	84,85	91,64	95,70
147 mm	50	107,77	107,77	116,39	122,35
197 mm	50	125,83	125,83	135,89	143,65
247 mm	50	139,03	139,03	150,15	160,09
297 mm	50	160,32	160,32	173,15	179,76
347 mm	50	175,14	175,14	189,15	201,06
397 mm	50	216,04	216,04	233,32	238,72
447 mm	50	247,40	247,40	267,19	283,04
497 mm	50	267,61	267,61	289,02	306,49
547 mm	50	305,86	305,86	330,33	344,74
597 mm	50	329,77	329,77	356,15	371,89
647 mm	50	349,08	349,08	377,01	394,44
697 mm	50	365,43	365,43	394,67	410,79
747 mm	50	391,83	391,83	423,17	437,19
797 mm	50	408,84	408,84	441,55	457,44
847 mm	50	423,00	423,00	456,84	474,84
897 mm	50	437,58	437,58	472,59	495,90





# ALUMİNYUM CNC

## Aluminium Cnc



Zafer 50

3043

- Siyah
- Krom
- İnox
- Altın



ÖLÇÜ / mm		Siyah	Krom	İnox	Altın
Code : 3043					
50					
47 mm	50	62,50	62,50	67,50	74,49
97 mm	50	82,77	82,77	89,39	93,62
147 mm	50	104,65	104,65	113,02	119,23
197 mm	50	121,68	121,68	131,41	139,50
247 mm	50	133,84	133,84	144,55	154,90
297 mm	50	154,11	154,11	166,44	173,55
347 mm	50	167,90	167,90	181,33	193,82
397 mm	50	207,77	207,77	224,39	230,45
447 mm	50	238,09	238,09	257,14	273,73
497 mm	50	257,27	257,27	277,86	296,15
547 mm	50	294,49	294,49	318,05	333,37
597 mm	50	317,37	317,37	342,76	359,49
647 mm	50	335,64	335,64	362,50	381,00
697 mm	50	350,97	350,97	379,04	396,33
747 mm	50	376,33	376,33	406,43	421,69
797 mm	50	392,31	392,31	423,70	440,91
847 mm	50	405,44	405,44	437,87	457,28
897 mm	50	418,99	418,99	452,51	477,31

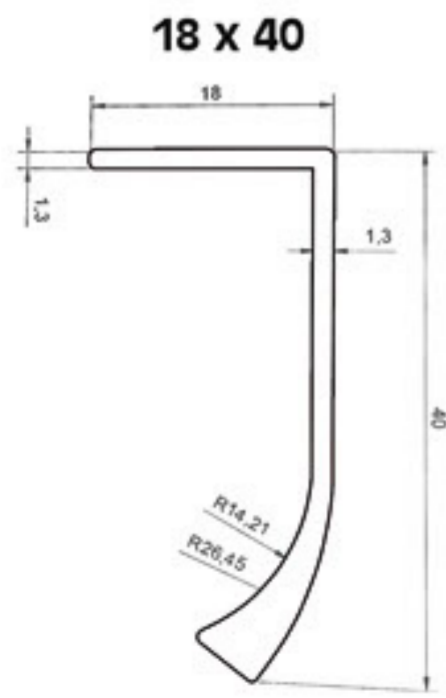

ALM  
CNC



134





**50 Çimen**
**3044**

- Siyah ●
- Krom ●
- İnox ●
- Altın ●

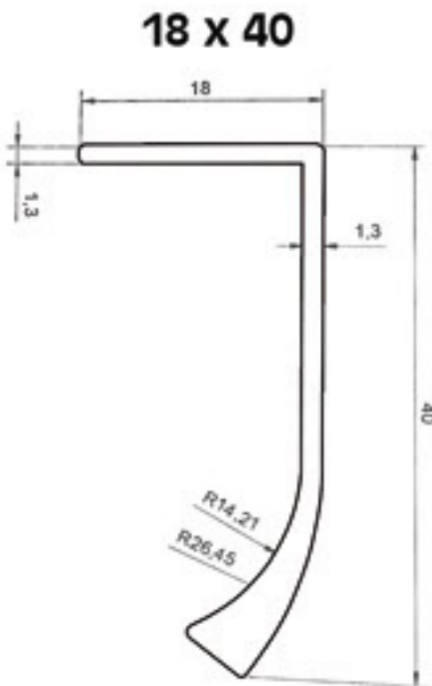

ÖLÇÜ / mm		Siyah	Krom	İnox	Altın
Code : 3044					
 50					
47 mm	50	46,30	46,30	50,00	58,29
97 mm	50	56,85	56,85	61,39	67,70
147 mm	50	72,25	72,25	78,03	86,83
197 mm	50	89,28	89,28	96,42	107,10
247 mm	50	101,44	101,44	109,56	122,50
297 mm	50	121,71	121,71	131,45	141,15
347 mm	50	135,50	135,50	146,34	161,42
397 mm	50	152,69	152,69	164,90	175,37
447 mm	50	183,01	183,01	197,65	218,65
497 mm	50	202,19	202,19	218,37	241,07
547 mm	50	239,41	239,41	258,57	278,29
597 mm	50	262,29	262,29	283,27	304,41
647 mm	50	280,56	280,56	303,01	325,92
697 mm	50	295,89	295,89	319,56	341,25
747 mm	50	321,25	321,25	346,95	366,61
797 mm	50	337,23	337,23	364,21	385,83
847 mm	50	350,36	350,36	378,39	402,20
897 mm	50	363,91	363,91	393,02	422,23





# ALUMİNYUM CNC

## Aluminium Cnc



Çınar 50

3045

- Siyah
- Krom
- İnox
- Altın



ÖLÇÜ / mm		Siyah	Krom	İnox	Altın
Code : 3045					
50					
47 mm	50	47,35	47,35	51,14	59,34
97 mm	50	58,93	58,93	63,65	69,78
147 mm	50	75,37	75,37	81,40	89,95
197 mm	50	93,43	93,43	100,90	111,25
247 mm	50	106,63	106,63	115,16	127,69
297 mm	50	127,92	127,92	138,16	147,36
347 mm	50	142,74	142,74	154,16	168,66
397 mm	50	160,96	160,96	173,84	183,64
447 mm	50	192,32	192,32	207,71	227,96
497 mm	50	212,53	212,53	229,54	251,41
547 mm	50	250,78	250,78	270,85	289,66
597 mm	50	274,69	274,69	296,67	316,81
647 mm	50	294,00	294,00	317,52	339,36
697 mm	50	310,35	310,35	335,18	355,71
747 mm	50	336,75	336,75	363,68	382,11
797 mm	50	353,76	353,76	382,06	402,36
847 mm	50	367,92	367,92	397,36	419,76
897 mm	50	382,50	382,50	413,10	440,82

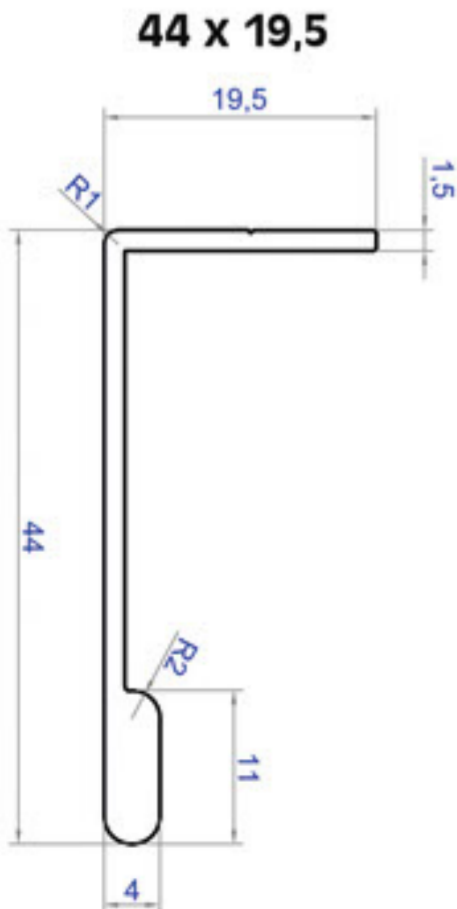

ALM  
CNC

136





# Porselen

Porselen Mobilya Kulpları Mutfaklarınıza  
Modern Bir Zarafet Katacak...

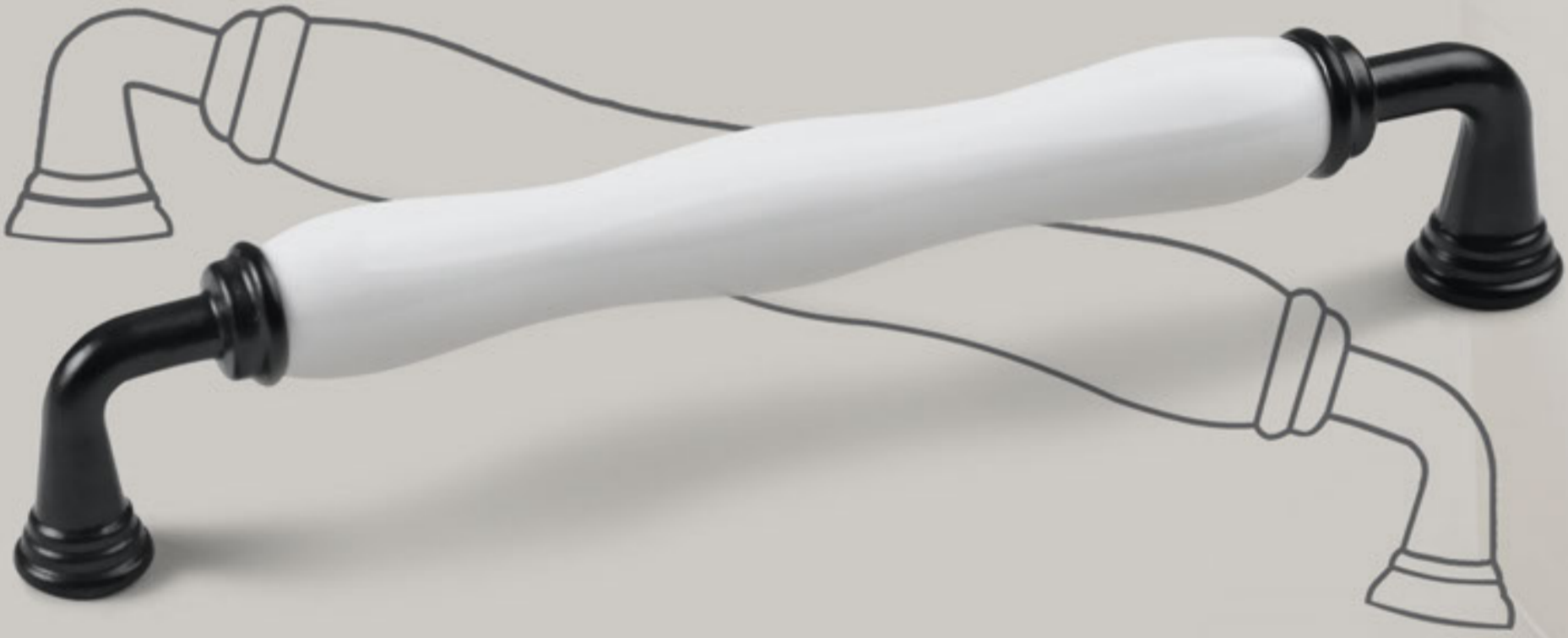

Porselen Mutfak Kulpları Siyah - Krom - İnox  
İtin ve Daha Birçok Renk Seçenekleri ile Sizlerin Beğenisine Sunulmaktadır.









## 50 Cengo

- Siyah ●
- Krom ●
- Inox ●
- Altın ●

4000

T.T.No: 2017 / 00430



Cengo Porselen	ÖLÇÜ	İkon	Siyah	Krom	Altın
1013	160 mm	50	88,00	98,50	104,50



## 50 Salkım

- Siyah ●
- Krom ●
- Inox ●
- Altın ●

4001



## Salkım Düğme

Poli / Pors

Salkım Porselen	ÖLÇÜ	İkon	Siyah	Krom	Antik	Altın
1013	96 mm	50	49,00	56,00	54,00	61,00
	128 mm	50	70,00	75,50	78,00	84,00
	160 mm	50	81,00	84,00	84,00	90,00
Salkım Düğme		50	49,50	50,00	50,00	54,00
1013						



# PORSELEN SERİSİ

Porcelain Handle

DEĞİŞİM



Zarif 50

4002

T.T.No: 2017 / 04341

● Siyah

● Krom

● İnox

● Altın



## Zarif Düğme

Poli / Pors



Zarif Porselen	ÖLÇÜ		Siyah	Krom	Antik	Altın
1013	96 mm	50	49,00	56,00	54,00	61,00
	128 mm	50	70,00	75,50	78,00	84,00
	160 mm	50	81,00	84,00	84,00	90,00
Zarif Düğme		50	49,50	50,00	50,00	54,00
1013						



Yaprak 50

4003

T.T.No: 2017 / 00430

● Siyah

● Krom

● İnox

● Altın



Yaprak	ÖLÇÜ		Siyah	Krom	Altın
1013	160 mm	50	71,00	83,00	87,50

PORCE  
LAIN

138



**50 Sude Düz**

- Siyah ●
- Krom ●
- İnox ●
- Altın ●

 4004  
Polimer

**Sude Düğme**

Polimer

Sude Düz	ÖLÇÜ		Siyah	Krom	Antik	Altın
1013	96 mm	50	45,00	45,00	45,00	48,00
	128 mm	50	47,00	47,00	47,00	48,50
Sude Düğme			28,00	31,00	28,00	32,50
1013						

**Pana**

 4005  
Porselen

Pana Porselen	ÖLÇÜ		Siyah	Krom	Antik	Altın
1013	128 mm	50	58,00	65,50	64,00	72,50



# PORSELEN SERİSİ

Porcelain Handle

DEĞİŞİM



Seçil Düğme  
Polimer



Seçil



50

4006  
Polimer

- Siyah
- Krom
- İnox
- Altın

Seçil Polimer	ÖLÇÜ	İkon	Siyah	Krom	Antik	Altın
1013	128 mm	50	28,00	30,00	26,50	36,00

Seçil Düğme	ÖLÇÜ	İkon	Siyah	Krom	Antik	Altın
1013		50	24,00	24,00	21,50	29,00



Palmira Düğme  
Polimer



Palmira



50

4007  
Polimer

- Siyah
- Krom
- İnox
- Altın

Palmira Polimer	ÖLÇÜ	İkon	Siyah	Krom	Antik	Altın
1013	96 mm	50	31,00	31,00	28,50	36,00
	128 mm	50	33,50	33,50	33,50	39,50

Palmira Düğme	ÖLÇÜ	İkon	Siyah	Krom	Antik	Altın
1013		50	24,00	24,00	21,50	29,00

PORCE  
LAIN

140





# Askı / Portmanto

Kaliteli Metal Ürünlerden Zamak İle Üretilmiş  
Estetik Mobilya Aksesuarları ve Kulplar.











50

**Petek**

Siyah ●

Krom ●

Inox ●

Altın ●

Portmanto

5000



**Petek**

Askı  
5001

**Petek Portmanto**



Siyah

Krom

Antik

Altın

5000

50

54,00

54,00

62,75

66,00

**Petek Askı**

50

40,50

40,50

46,00

50,00

5001



50

**Mira**

Siyah ●

Krom ●

Inox ●

Altın ●

Portmanto

5002



**Mira**

Askı  
5003

**Mira Portmanto**



Siyah

Krom

Antik

Altın

5002

50

55,00

55,00

64,00

67,00

**Mira Askı**

50

42,00

42,00

44,00

44,00

5003

HOOK  
COAT  
RACK

141



# ASKI / PORTMANTO

Hook / Coat Rack

DEĞİŞİM

## Sultan

Askı  
5004

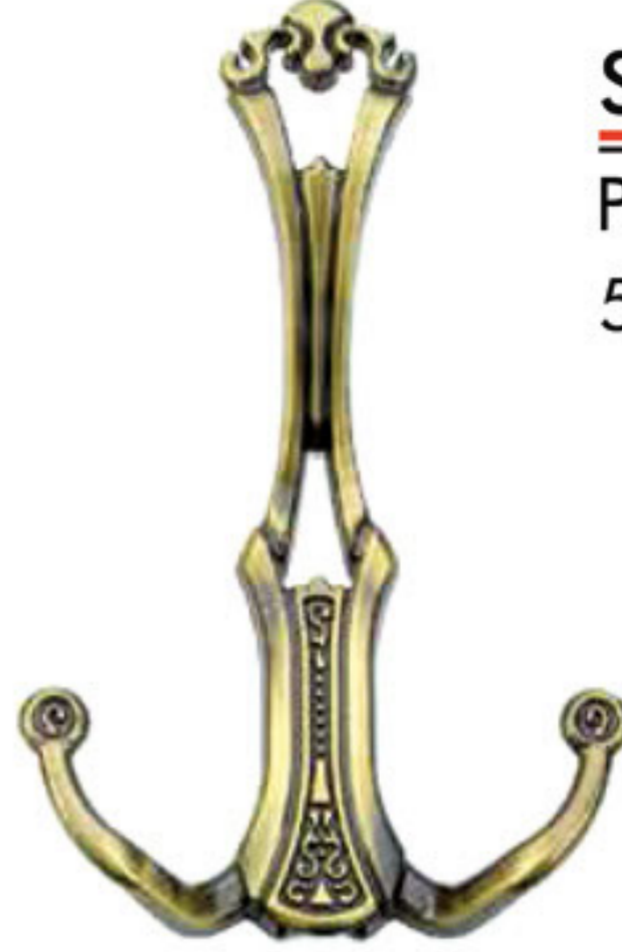

Sultan



50

Portmanto  
5005

- Siyah
- Krom
- İnox
- Altın

Sultan Portmanto	Box	Siyah	Krom	Antik	Altın
5004	50	55,00	55,00	64,00	67,00
Sultan Askı	Box	Siyah	Krom	Antik	Altın
5005	50	41,00	41,00	45,00	45,00

## Lilyum

Askı  
5006  
T.T.No: 2016 / 05435



Lilyum



50

Portmanto  
5007  
T.T.No: 2016 / 05435

- Siyah
- Krom
- İnox
- Altın

Lilyum Portmanto	Box	Siyah	Krom	Altın
5006	50	59,50	59,50	67,50
Lilyum Askı	Box	Siyah	Krom	Altın
5007	50	44,00	44,00	52,00

HOOK  
COAT  
RACK

142





50

**Sirma**

Siyah ●

Krom ●

Inox ●

Altın ●

**Portmanto  
5008**

T.T.No: 2016 / 05435



**Sirma**

**Askı  
5009**

T.T.No: 2016 / 05435

**Sirma Portmanto**

5008



50

Siyah

59,50

Krom

59,50

Antik

67,50

Altın

67,50

**Sirma Askı**

5009

50

39,00

39,00

46,50

47,00



50

**Rota**

Siyah ●

Krom ●

Inox ●

Altın ●

**Portmanto  
5010**



**Rota**

**Askı  
5011**

**Rota Portmanto**

5010



50

Siyah

35,50

Krom

39,00

Saten

39,00

**Rota Askı**

5011

50

22,00

24,50

24,50

HOOK  
COAT  
RACK

143



# ASKI / PORTMANTO

Hook / Coat Rack



## Okyanus

Askı  
5012



Okyanus



50

Portmanto  
5013

● Siyah

● Krom

● İnox

● Altın

### Okyanus Portmanto

5012



50

Siyah

53,00

Krom

53,00

Antik

62,00

Altın

62,00

### Okyanus Askı

5013

50

39,00

39,00

42,00

42,00

## Elmas

Askı  
5014



Elmas



50

Portmanto  
5015

● Siyah

● Krom

● İnox

● Altın

### Elmas Portmanto

5014



50

Siyah

42,50

Krom

42,50

Antik

49,00

Altın

51,00

### Elmas Askı

5015

50

29,0

29,00

34,00

34,00

HOOK  
COAT  
RACK

144





50

**Mina**

Siyah ●

Krom ●

Antik ●

Saten ●

Portmanto  
5016



**Mina**

Askı  
5017

#### Mina Portmanto

5016



50

Siyah

74,00

Krom

82,00

Antik

85,00

Saten

82,00

#### Mina Askı

5017

50

50,00

53,50

56,50

53,50



50

**Efes**

Siyah ●

Krom ●

Antik ●

Saten ●

Portmanto  
5018



**Cengo**

Portmanto  
5019



#### Efes Portmanto

5018



50

Siyah

75,00

Krom

75,00

Antik

87,00

Altın

87,00

#### Cengo Portmanto

5019

50

72,50

75,00

87,50

84,00

HOOK  
COAT  
RACK

145



# ASKI / PORTMANTO

Hook / Coat Rack

DEĞİŞİM

## Damla

Aski  
5020



Damla



50

Portmanto  
5021

● Siyah

● Krom

● İnox

● Altın

### Damla Portmanto

5020



50

Siyah

41,50

Krom

49,00

Antik

49,00

Saten

49,00

### Damla Aski

5021

50

26,50

31,50

33,00

31,50

## Motif

Aski  
5022



Motif



50

Portmanto  
5023

● Siyah

● Krom

● İnox

● Altın

### Motif Portmanto

5022



50

Siyah

59,00

Krom

75,00

Antik

91,00

Altın

91,0

### Motif Aski

5023

50

51,00

59,00

72,00

72,00

HOOK  
COAT  
RACK

146





50

**Kesit**

Portmanto  
5024

T.T.No: 2023 / 00868

- Siyah ●
- Krom ●
- Inox ●
- Altın ●



Kesit Portmanto	Box	Fiyat
Siyah	50	72,50
Krom	50	72,50
Antik	50	77,00
Altın	50	81,00

**Kobra**

Askı  
5025



Kobra Askı	Box	Fiyat
Siyah	50	22,00
Krom	50	24,50
Saten	50	24,50



50

**Roket**

Askı  
5026

- Siyah ●
- Krom ●
- Inox ●
- Altın ●



Roket Askı	Box	Siyah	Krom	Saten	M.Krom
5026	50	18,00	18,00	18,00	18,00
Lale Askı	Box	Siyah	Krom	Saten	M.Krom
5027	50	21,00	21,00	21,00	21,00

**Lale**

Askı  
5027





# ASKI / PORTMANTO

Hook / Coat Rack



## Tuana

Askı  
5028



## Tuana

Portmanto  
5029



50

- Siyah
- Krom
- İnox
- Altın

### Tuana Portmanto

5028



Siyah

Krom

Antik

Altın

50

41,70

44,70

44,70

52,00

### Tuana Askı

5029

50

32,00

35,50

35,50

40,00

## Fiko

Askı  
5030



## Fiko

Portmanto  
5031



50

- Siyah
- Krom
- İnox
- Altın

### Fiko Portmanto

5030



Siyah

Krom

Saten

M.Krom

50

45,00

45,00

45,00

45,00

### Fiko Askı

5031

50

28,00

28,00

28,00

28,00

HOOK  
COAT  
RACK

148



**50**
**Barla**

- Siyah ●
- Krom ●
- İnox ●
- Altın ●

**Portmanto  
5032**

**Barla**
**Askı  
5033**
**Barla Portmanto**
**5032**

**50**
**Siyah**

43,00

**Krom**

43,00

**Antik**

49,00

**Altın**

50,50

**Barla Askı**
**5033**
**50**
**Siyah**

30,00

**Krom**

30,00

**Antik**

33,00

**Altın**

35,00

**50**
**Manolya**

- Siyah ●
- Krom ●
- İnox ●
- Altın ●

**Portmanto  
5034**

**Manolya**
**Askı  
5035**
**Manolya Portmanto**
**5034**

**50**
**Siyah**

62,50

**Krom**

62,50

**Antik**

74,50

**Altın**

75,50

**Manolya Askı**
**5035**
**50**
**Siyah**

32,00

**Krom**

32,00

**Antik**

36,50

**Altın**

41,50

**HOOK  
COAT  
RACK**
**149**

# ASKI / PORTMANTO

Hook / Coat Rack



## Noktalı Manolya

Noktalı Askı  
5036



Noktalı Manolya



50

Noktalı Portmanto  
5037

- Siyah
- Krom
- İnox
- Altın

Noktalı Manolya Portmanto	Box	Siyah	Krom	Antik	Altın
5036	50	68,00	68,00	81,50	81,50
Noktalı Manolya Askı	Box	Siyah	Krom	Antik	Altın
5037	50	34,50	34,50	38,00	42,50

## Noktalı

Askı  
5038



Noktalı Portmanto  
5039



50

- Siyah
- Krom
- İnox
- Altın

Noktalı Portmanto	Box	Siyah	Krom	Saten	M.Krom
5038	50	27,00	28,00	28,00	28,00
Noktalı Askı	Box	Siyah	Krom	Saten	M.Krom
5039	50	19,00	20,00	20,00	20,00

HOOK  
COAT  
RACK

150





50

## Palmira

- Siyah ●
- Krom ●
- İnox ●
- Altın ●

Portmanto  
5040



## Palmira

Askı  
5041



### Palmira Portmanto

5040



50

Siyah

32,00

Krom

35,00

Antik

31,00

Altın

43,50

### Palmira Askı

5041



50

27,00

27,50

25,50

34,50



50

## Kristal

- Siyah ●
- Krom ●
- İnox ●
- Altın ●

Portmanto  
5042



## Kristal

Askı  
5043



### Kristal Portmanto

5042



50

Siyah

32,00

Krom

36,00

Saten

36,00

M.Krom

36,00

### Kristal Askı

5043



50

22,00

24,50

24,50

24,50

HOOK  
COAT  
RACK

151

# ASKI / PORTMANTO

Hook / Coat Rack



Dizayn  
Eta  
Portmanto  
5044



Eta



50

Portmanto  
5045

- Siyah
- Krom
- İnox
- Altın

Dizayn Eta Portmanto	Box	Siyah	Krom	Saten	M.Krom
5044	50	32,00	37,00	37,00	37,00
Eta Portmanto	Box	Siyah	Krom	Saten	M.Krom
5045	50	44,00	48,00	48,00	48,00

Nur  
Aski  
5046



Nur



50

Portmanto  
5047

- Siyah
- Krom
- İnox
- Altın

Nur Portmanto	Box	Siyah	Krom	Antik	Altın
5046	50	46,40	46,40	53,50	56,50
Nur Aski	Box	Siyah	Krom	Antik	Altın
5047	50	45,50	45,50	52,50	50,50

HOOK  
COAT  
RACK

152





50

### Saray

- Siyah ●
- Krom ●
- İnox ●
- Altın ●

Portmanto  
5048

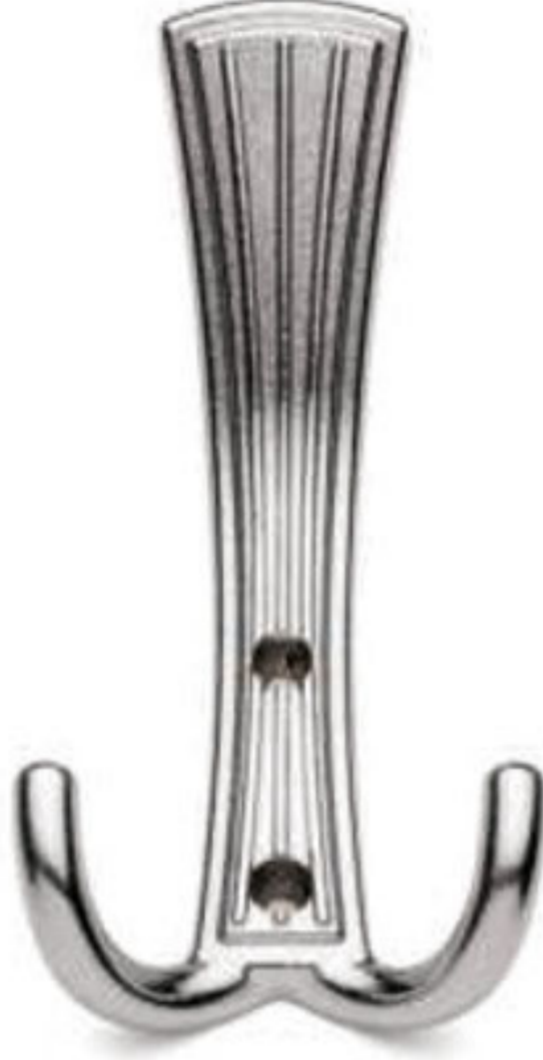

### Saray

Askı  
5049

**Saray Portmanto**



Siyah

Krom

Antik

Altın

5048

50

40,50

43,50

43,50

50,50

**Saray Askı**

50

30,00

33,00

33,00

37,00

5049



50

### Deniz

- Siyah ●
- Krom ●
- İnox ●
- Altın ●

Portmanto  
5050



### Deniz

Askı  
5051

**Deniz Portmanto**



Siyah

Krom

Antik

Altın

5050

50

40,50

43,50

43,50

50,50

**Deniz Askı**

50

30,00

33,00

33,00

37,00

5051

HOOK  
COAT  
RACK

153

# ASKI / PORTMANTO

Hook / Coat Rack

DEĞİŞİM

**Mali**

Askı  
5052



**Mali**

Portmanto  
5053



50

● Siyah

● Krom

● İnox

● Altın

Mali Portmanto	50	Siyah	Krom	Antik	Altın
5053	50	42,50	45,50	45,50	53,00
Mali Askı	50	Siyah	Krom	Antik	Altın
5052	50	30,50	33,50	33,50	37,50

**Troy**

Askı  
5054



**Troy**

Portmanto  
5055



50

● Siyah

● Krom

● İnox

● Altın

Troy Portmanto	50	Siyah	Krom	Antik	Altın
5055	50	40,50	43,50	43,5	50,50
Troy Askı	50	Siyah	Krom	Antik	Altın
5054	50	30,00	33,00	33,00	37,00

HOOK  
COAT  
RACK

154





# Düğmeler

Kaliteli Alüminyum Metal T - Profilden Üretilmiş  
Estetik Mobilya Aksesuarları ve Düğmeler...

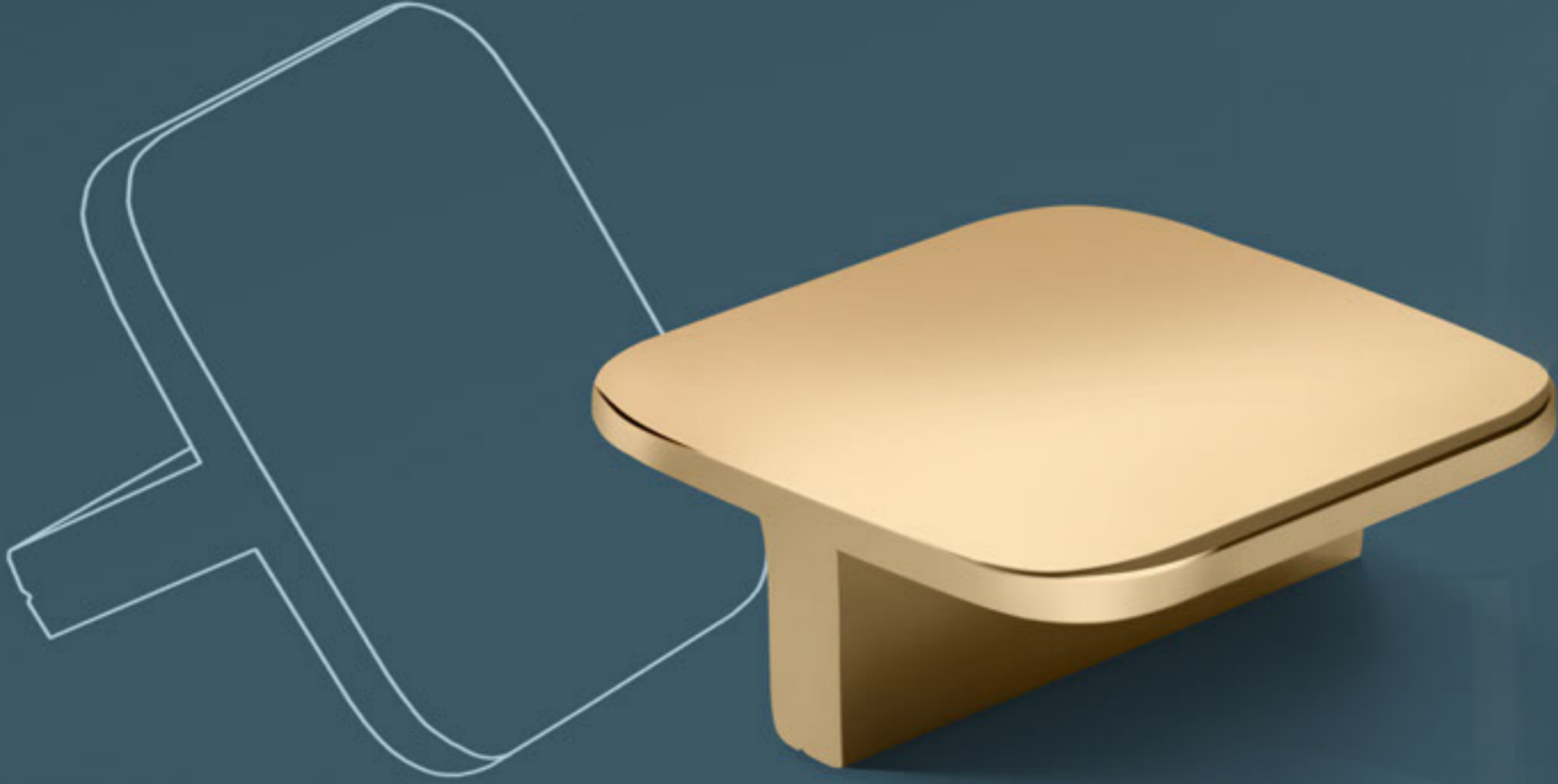

32 mm Alüminyum ( T ) Profil Düğmeler. Siyah - Krom  
Altın - İnox Renk Seçenekleri İle ; Yeni Zinde Düğme  
Modelimiz Ürün Stoklarımızda...



New Model  
Zinde







100

- Siyah ●
- Krom ●
- İnox ●
- Altın ●

6001



Yuvarlak

100

Renk	Fiyat
Siyah	22,38
Krom	27,84
İnox	30,62
Altın	33,69

6002



Kare

100

Renk	Fiyat
Siyah	22,38
Krom	27,84
İnox	30,62
Altın	33,69

6003



Çizgili

100

Renk	Fiyat
Siyah	25,00
Krom	31,00
Antik	28,00
Altın	32,50

6004



Düz

100

Renk	Fiyat
Siyah	20,00
Krom	22,00
Saten	22,00

6005



Çift Baklava

100

Renk	Fiyat
Siyah	20,00
Krom	22,00
Saten	22,00

6006



Baklava

100

Renk	Fiyat
Siyah	20,00
Krom	22,00
Saten	22,00

6007



Noktalı

100

Renk	Fiyat
Siyah	20,00
Krom	22,00
Saten	22,00

6008



Asus

100

Renk	Fiyat
Siyah	18,00
Krom	21,00
Antik	24,00
Altın	24,00

6009



Piramit

100

Renk	Fiyat
Siyah	19,50
Krom	21,50
Antik	25,00
Altın	25,00



6010



Adonis

100

Renk	Fiyat
Siyah	20,50
Krom	20,50
İnox / Antik	22,00
Altın	27,00

6011



Defne

100

Renk	Fiyat
Siyah	21,00
Krom	21,00
İnox / Antik	23,50
Altın	27,50

6012



T.T.No: 2020 / 04231

Midas

100

Renk	Fiyat
Siyah	33,00
Krom	41,00
Antik	35,00
Altın	45,00



100

- Siyah
- Krom
- İnox
- Altın

6013



Elevit

100

Renk	Fiyat
Siyah	18,00
Krom	20,00
Saten	20,00

6014



Mermi

100

Renk	Fiyat
Siyah	24,00
Krom	27,00
Saten	27,00

6015



Misket

100

Renk	Fiyat	
	19mm	25mm
Siyah	24,00	34,00
Krom	26,50	36,00
Saten	26,50	36,00

6016



T.T.No: 2017 / 00430

Kesit

100

Renk	Fiyat
Siyah	23,00
Krom	23,00
Antik	23,50
Altın	24,50

6017



T.T.No: 2020 / 02197

Dekor

100

Renk	Fiyat
Siyah	31,00
Krom	33,00
Antik	35,50
Altın	34,50

6018



Halka Sarkaç

100

Renk	Fiyat
Siyah	30,00
Krom	30,00
Antik	34,00
Altın	38,00

KNOB  
BUTTONS

156



## ÇALIŞMA ŞARTLARI

- 1 - Her Ay Sonu Bakiyeye Bakılmaksızın Cari Hesap Kapatılır.
- 2 - Vadeli Satışlarımız Fatura Tarihi İtibari İle 90 Gündür.
- 3 - Özel Siparişler Onaylandıktan Sonra İmalata Başlanır. Hangi Şartla Olursa Olsun İadesi Kesinlikle Kabul Edilmez.
- 4 - Ürünlerimizde Üretimden Kaynaklanan Bir Hata Yok İse İade Alınmaz
- 5 - Sipariş Miktarının Tamamlanması İstenererek Ödemeler Şarta Bağlanamaz
- 6 - Müşteri Ürün Talebi, Sipariş Tarihi ve Ödeme Önceliği Dikkate Alınarak Sevk Edilir.
- 7 - Malzeme Teslim Yeri Fabrikamız Olup, Nakliye Bedeli Alıcıya Aittir.
- 8 - Karşılıksız Çeklerin Ödemesi 15 Günü Geçtiği Taktirde Ürün Sevkiyatı Durdurulur.
- 9 - Firmamız Önceden Haber Vermeksizin Fiyatları ve Satış Şartlarını Değitirme Hakkını Saklı Tutar.
- 10 - Her Yeni Fiyat Listesi Öncekini Geçersiz Kılar.
- 11 - Fiyatlarımıza KDV Dahil Değildir.

+90 (212) 565 60 57 / +90 (546) 776 38 99 / +90 (535) 838 60 43

degisimkulp.com / degisimkulp@gmail.com





**TURK PATENT**  
T.C. SANAYİ VE TEKNOLOJİ BAKANLIĞI

**MARKA TESCİL BELGESİ**  
No: 2023 089618 - Ticaret - Hizmet

KÜÇÜK ŞEYLER FARK YARATIR

**DEĞİŞİM KULP**

Marka Sahibi  
**DEĞİŞİM KULP MOBİLYA AKSESUARLARI SANAYİ TİCARET LİMİTED ŞİRKETİ**

Mal / Hizmet Sınıfları  
**06, 35**

Bu marka, 6769 sayılı Sınai Mülkiyet Kanunu kapsamında,  
11.07.2023 tarihinden itibaren 10 yıl süreyle korunmak üzere,  
30.11.2023 tarihinde tescil edilmiştir.

  
Prof. Dr. M. Zeki DURAK  
Kurum Başkanı

**TURK PATENT**  
T.C. SANAYİ VE TEKNOLOJİ BAKANLIĞI

**MARKA TESCİL BELGESİ**  
No: 2023 081459 - Ticaret - Hizmet

DEĞİŞİM KULP MOBİLYA  
AKSESUARLARI SANAYİ TİCARET  
LİMİTED ŞİRKETİ

Marka Sahibi  
**DEĞİŞİM KULP MOBİLYA AKSESUARLARI SANAYİ TİCARET LİMİTED ŞİRKETİ**

Mal / Hizmet Sınıfları  
**17, 42**

Bu marka, 6769 sayılı Sınai Mülkiyet Kanunu kapsamında,  
20.06.2023 tarihinden itibaren 10 yıl süreyle korunmak üzere,  
30.11.2023 tarihinde tescil edilmiştir.

  
Prof. Dr. M. Zeki DURAK  
Kurum Başkanı

**T.C. SANAYİ VE TEKNOLOJİ BAKANLIĞI**  
SANAYİ GENEL MÜDÜRLÜĞÜ

**SANAYİ SİCİL BELGESİ**  
e-belge

Belge Tarihi : 25/08/2020 | Belge No : 758486 | Vergi/TIC No : 2731189090

İşyeri İşletme Ünvanı : DEĞİŞİM KULP MOBİLYA AKSESUARLARI SANAYİ TİCARET LİMİTED ŞİRKETİ

İşyeri Adresi : TOPÇULAR MAHALLESİ RAMİ KIŞLA CADDESİ NO:142 NO:16/1-2 EYÜPSULTAN / İSTANBUL

Vize Tarihi : 25/08/2024 | Vize Ödeneği Bİlgi Tarihi : 25/08/2028

**Üretim Konusu**

METAL MOBİLYA AKSESUARLARI(TAKOZ,KULP VB.) ( )

Belge Başım Tarihi : 04/09/2024

Sanayi Sicil Belgesi 1/1, sayfa(s) : 1

**TÜRKİYE ODALAR VE BORSALAR BİRLİĞİ**  
İSTANBUL TİCARET ODASI

**KAPASİTE RAPORU**

Geçerlilik Süresi Sonu  
**28.02.2027**

Rapor Tarihi : 28.02.2022  
Rapor No : 1171

Firma Ünvanı : DEĞİŞİM KULP MOBİLYA AKSESUARLARI SANAYİ TİCARET LİMİTED ŞİRKETİ

Tescilli Markaları :  
Vergi Dairesi/No : Bayrampaşa V.D. / 2731189090  
İşyeri SGK No : 246470606123810903407-63  
MERSİS No : 0273-1189-0900-0001

Sanayi Sicil No : 758486  
Oda Sicil No : 1970625  
Ticaret Sicil No : 197062-5  
Faaliyet Kodu (NACE) : 46.47.01

Üretim Yaptığı Yer Adres : \*TOPÇULAR MAH. RAMİ KIŞLA CAD. NO:142 NO:16/1-2 EYÜPSULTAN / İSTANBUL

İşyeri Tel (Kodlu) : 212-5656057 | Faks : 212-5656057  
e-posta : hyelek@hotmail.com | Web :

Merkez Adres : \*TOPÇULAR MAH. RAMİ KIŞLA CAD. NO:142 NO:16/1-2 EYÜPSULTAN / İSTANBUL

Büro Tel (Kodlu) : 212-5656057 | Faks : 212-5656057

Üretim Konuları : Metal mobilya aksesuarları

Üretim Yeri Durumu	Sermaye Kıymetler Durumu (TL)	Personel Durumu
Kirwa : - Arazi (m2) : - Toplam Kapalı Alan (m2) : 750 İnşa İşletme Tipi : B.ARME	Makine ve Teçhizat Değeri : 190.000 Tescilli Sermayesi : 100.000	Mühendis : - Teknisyen : - Usta : - İşçi : 6 İdari Pers. : - Toplam : 6

Üretim Faaliyetine Başlama Tarihi : 21.07.2020

Yabancı Sermaye	Gayri Maddi Hak
Oranı (%)	Patent Know How Lisans Diğer

Sertifika lar :  
Yukarıda ünvanı yazılı işletmenin, işyerinde mevcut makine ve teçhizatın yürürlükteki yöntem ve kriterlere göre teorik olarak hesaplanan azami üretim kapasitesini ile tüketim kapasitesini kapsayan bu kapasite raporu 24.02.2022 günü taraflardan düzenlenmiştir.

RAPORTÖR	1.EKSPER	2.EKSPER
YÜKSEL AYDOĞDU Kapasite Servisi Raportörü	METİN AKYOL Makine Mühendisi	

  
ASLI GIBİDİR  
Bakıhan KAYA  
27-02-2022

**İSTANBUL TİCARET ODASI 1882**

**YERLİ ÜRETİM**

**Turkey**

Discover  
the potential





# DEĞİŞİM

furniture accessories

Topçular Mah. Rami Kışla Cad No:16, Eyüp / İstanbul.

+90 (212) 565 60 57 / +90 (546) 776 38 99 / +90 (535) 838 60 43

degisimkulp.com / degisimkulp@gmail.com



degisimkulp



degisimkulp

